

2  
=  
1

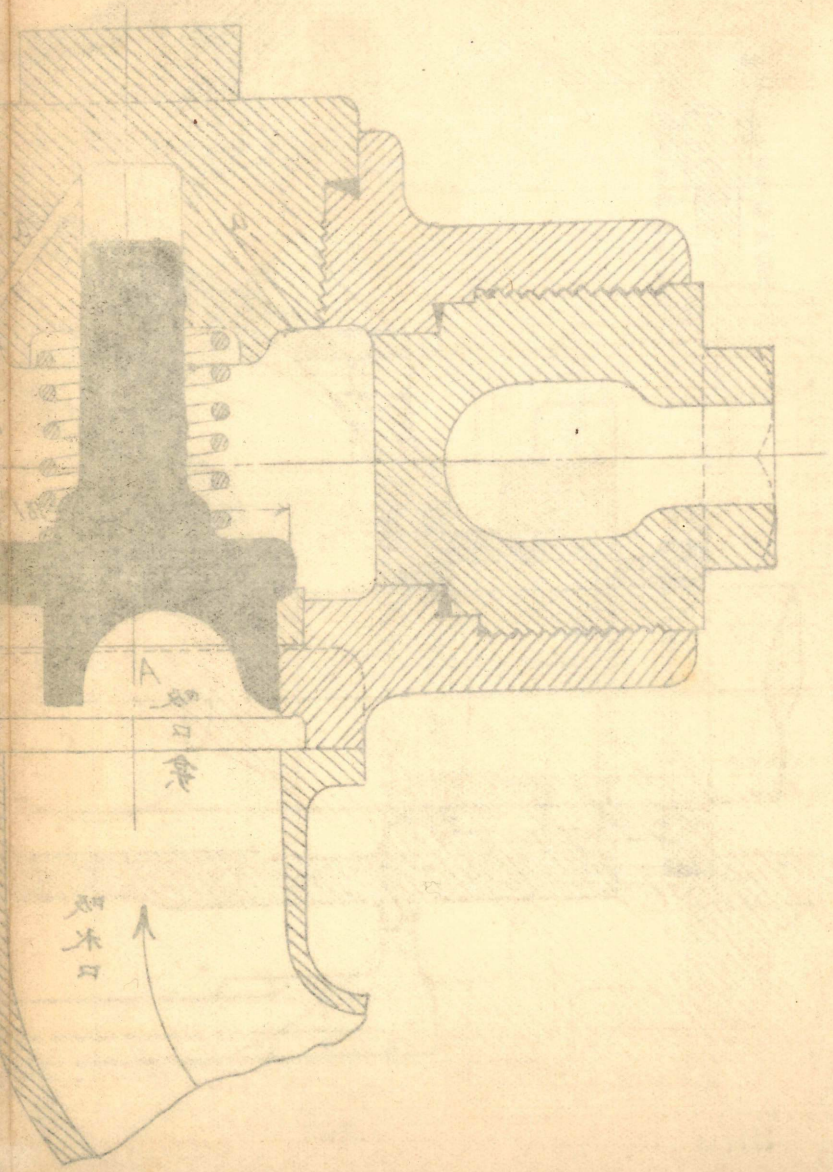

調整環

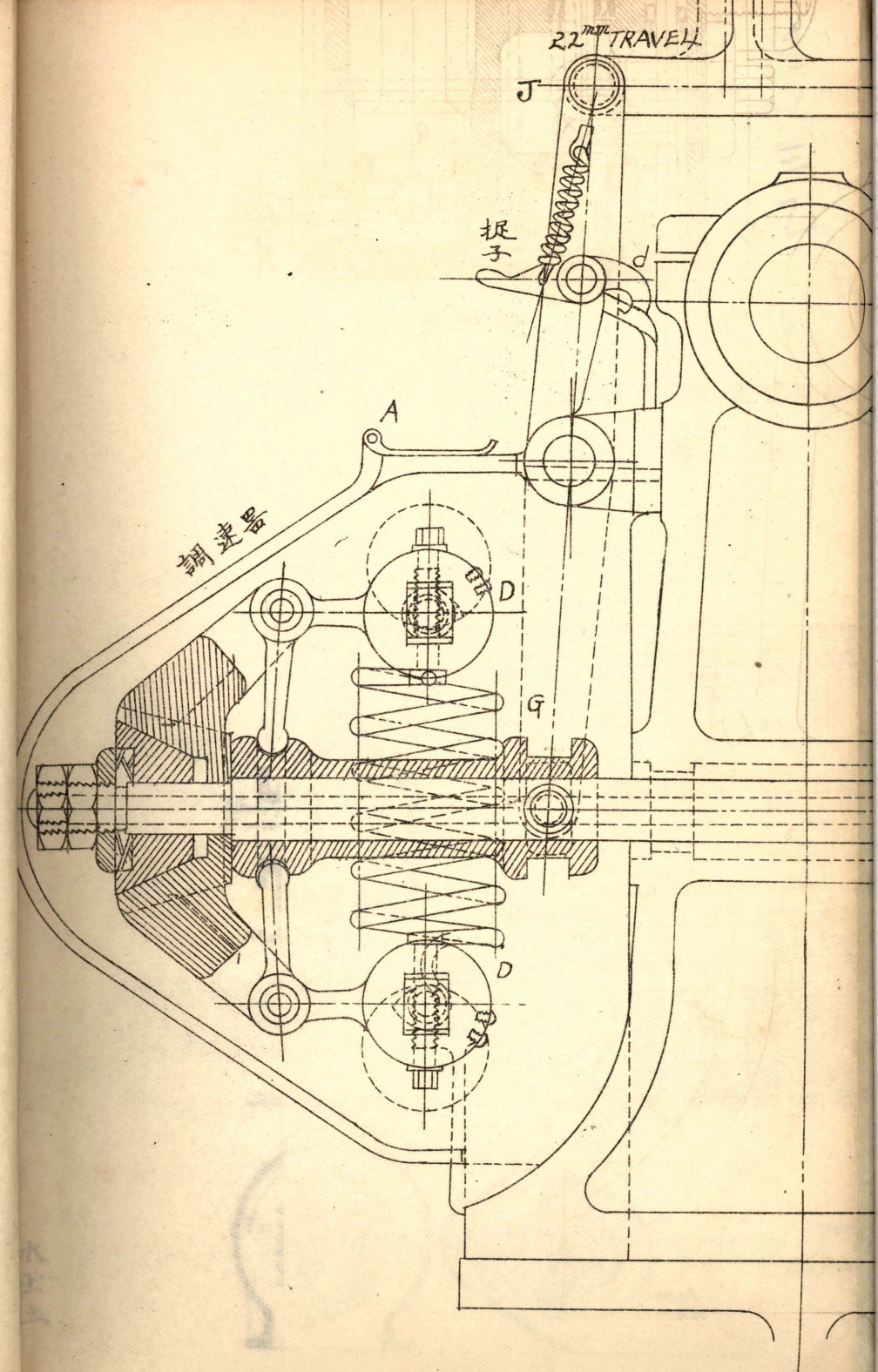
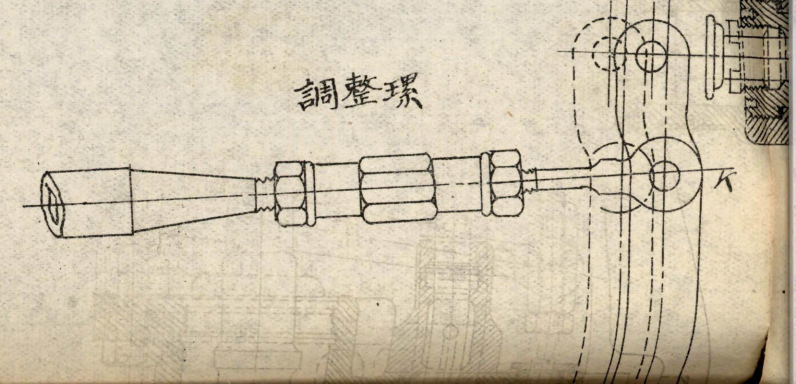

第1圖 三甲

659馬力水壓唧筒機械

水壓調理器及調速器

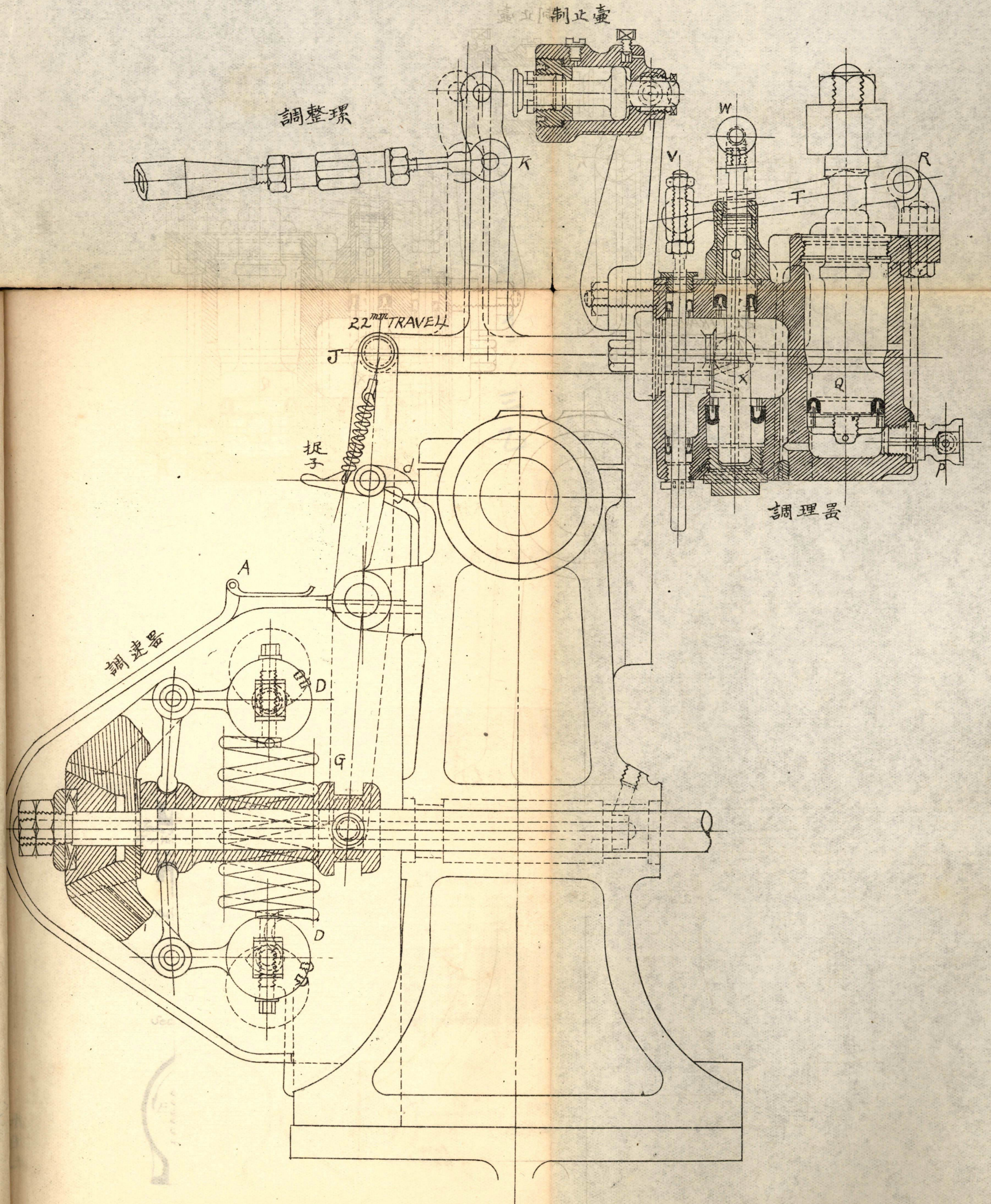

第1圖、三  
水圧調理器並前

(1)

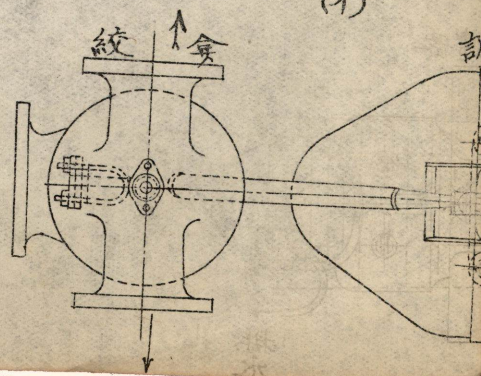

(2)

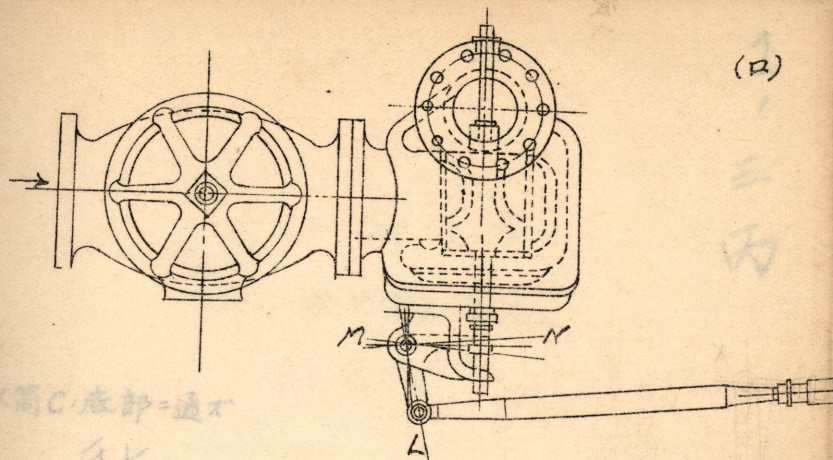

水筒C底部=通水

(3)

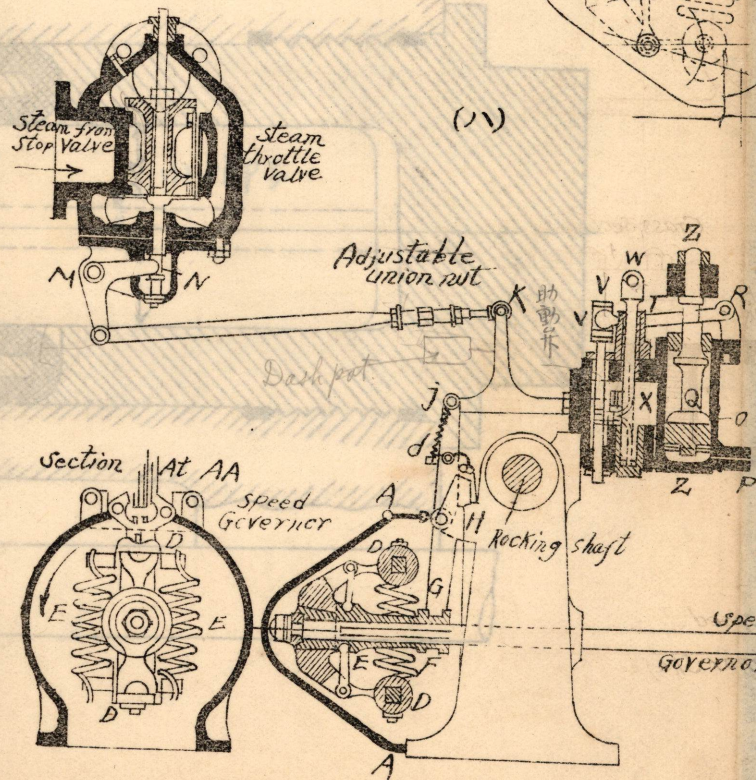

K  
五

由三ノ下

53 TRAVEL

外子

器製陸

Spe  
Governor

第1圖、三乙  
水圧調理器並調速器

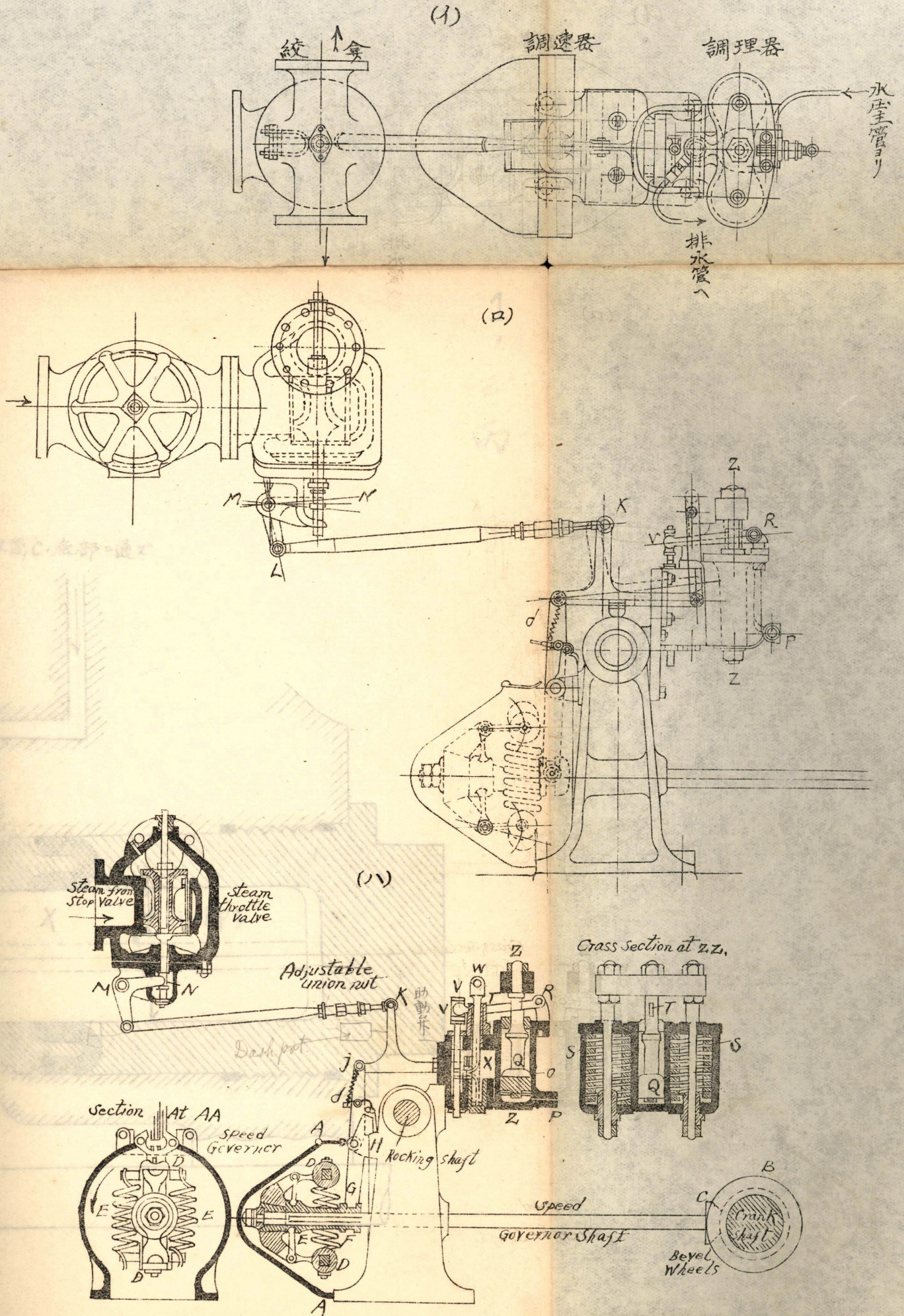

2  
3  
1

(B)

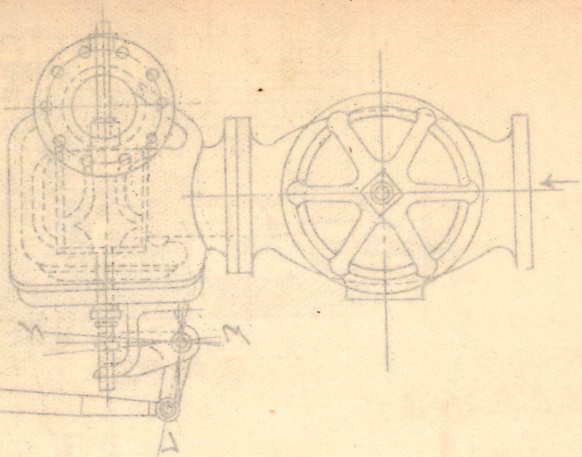

(C)

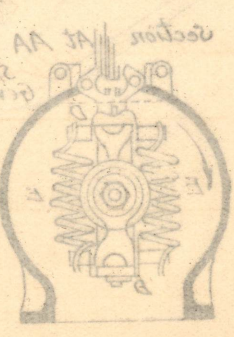
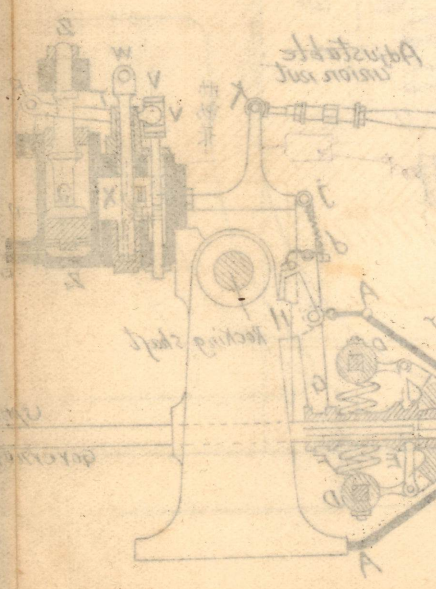

1  
3  
丙

丙之二、圖、帶  
有一、表、缸、能、及、水  
圖、大、船

水筒C、底部=通不

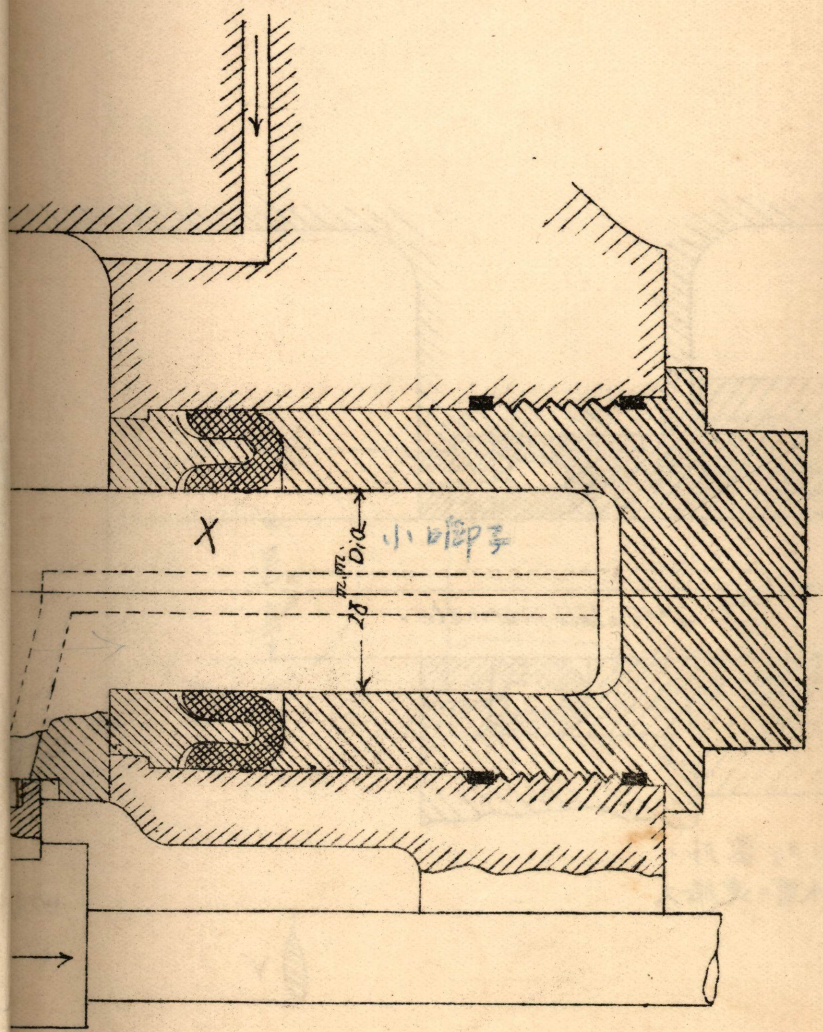

(B)

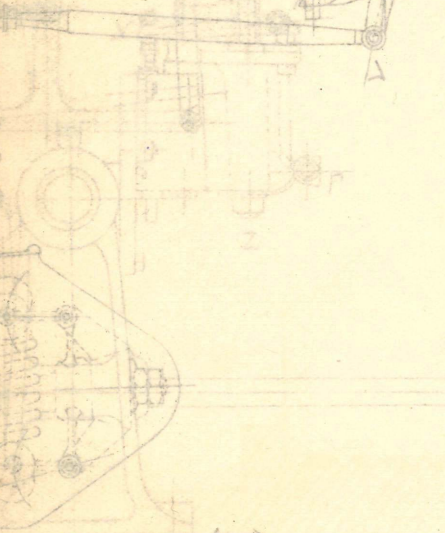
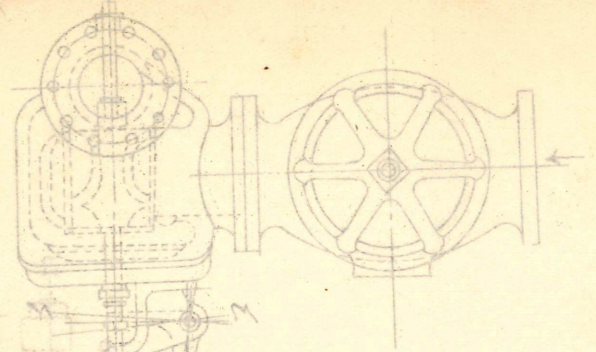

(C)

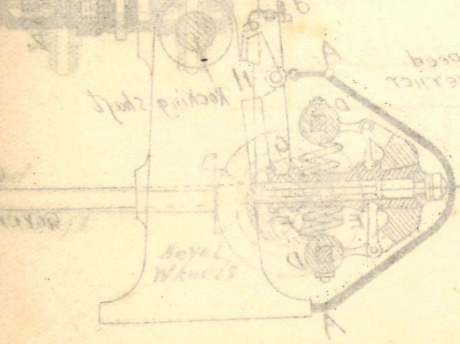
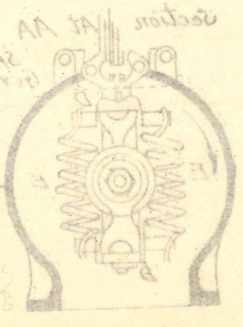
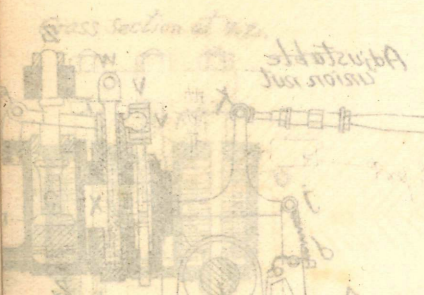
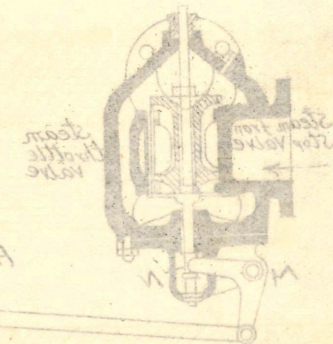

第1圖, 三丁 鉄弁  
659馬力水圧唧筒機械

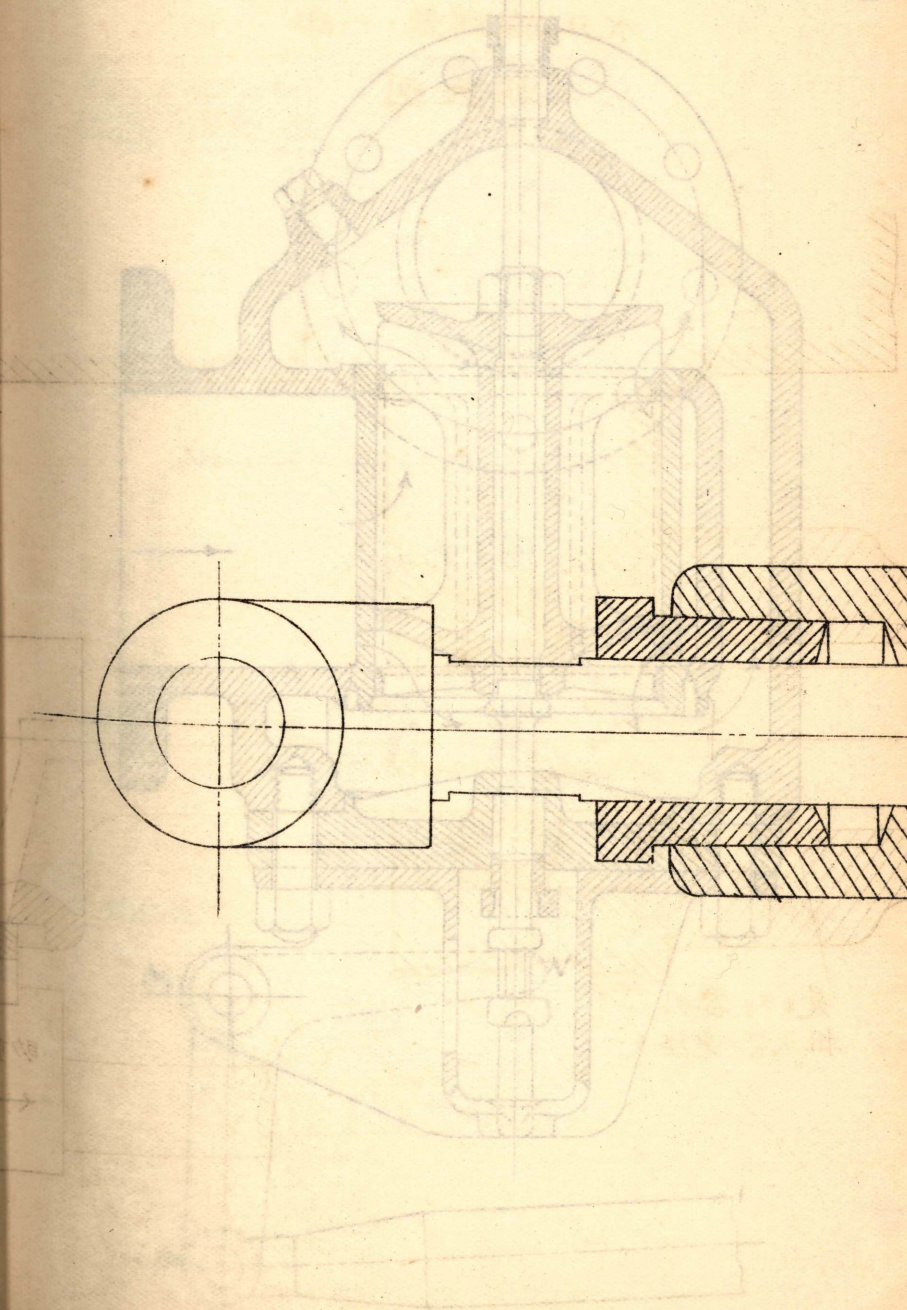

1/3丁

第1圖, 三丙  
水圧調理器, 一部  
擴大圖

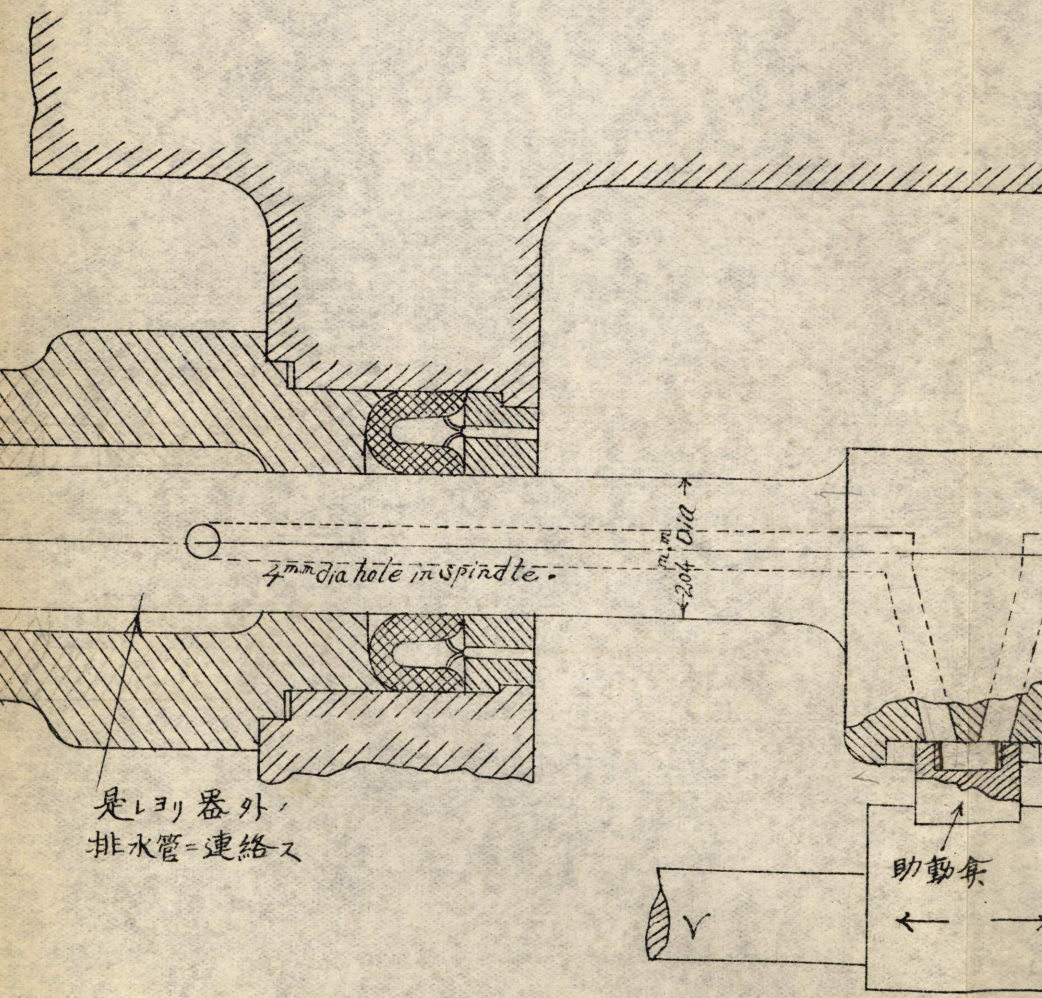

是レリ器外,  
排水管=連絡ス

助動弁

← →

1  
1  
3  
丁

第1图, 三丁  
659馬力水压唧筒機械

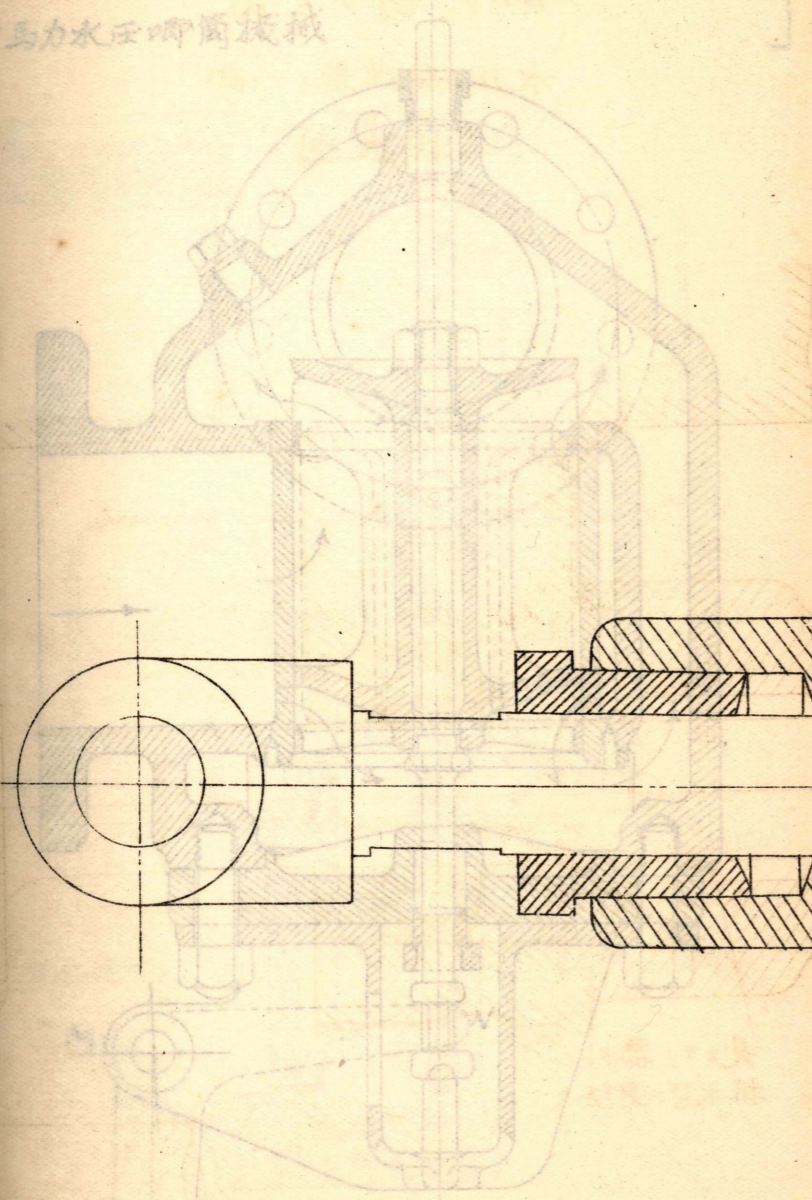

第1图, 三丙  
水压調理器, 一部  
擴大圖

1  
1  
3  
丙

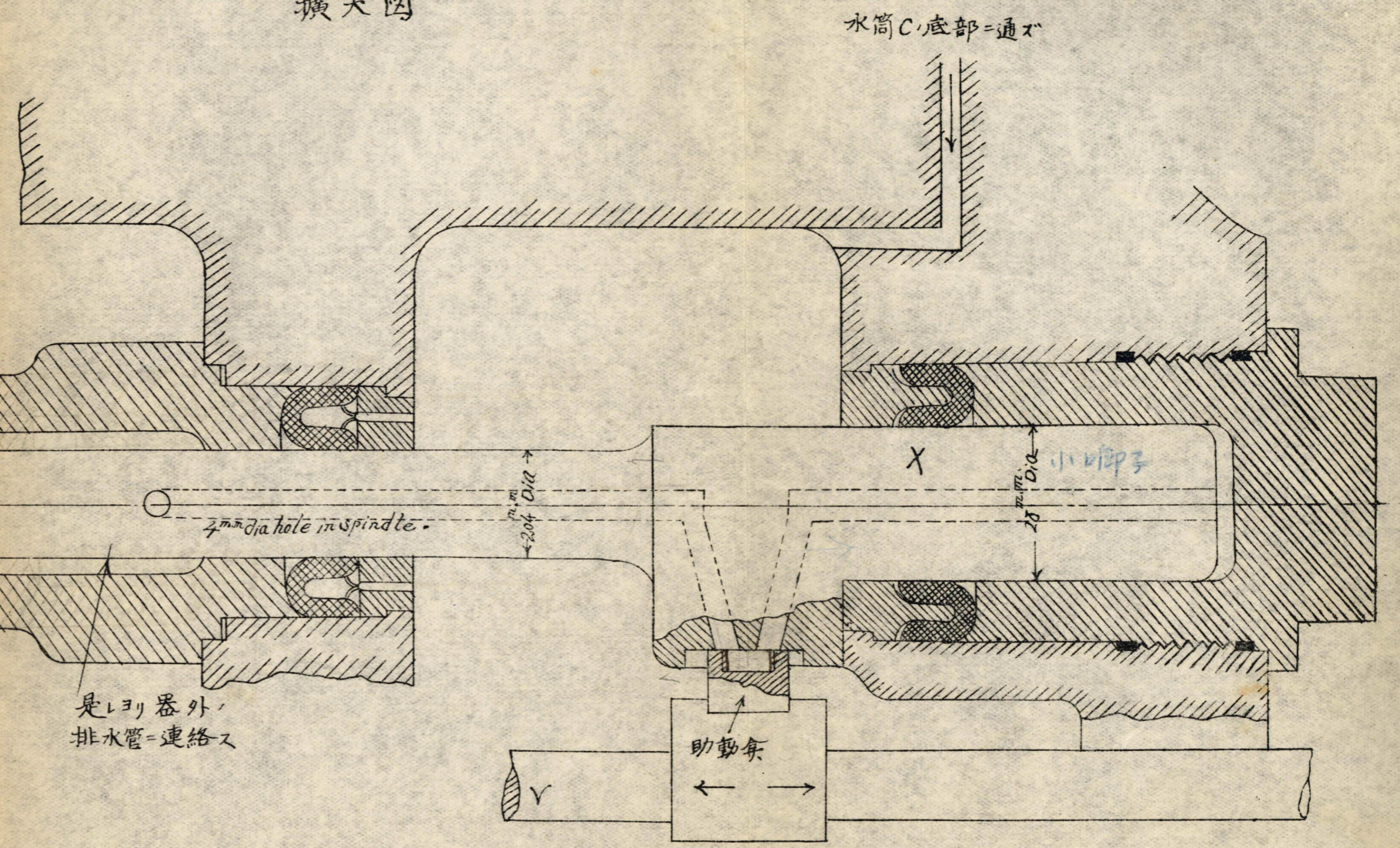

是L型器外,  
排水管=連絡又

水筒C, 底部=通水

4mm dia hole in spindle

Y  
助動泵  
← →

X  
20mm Dia  
小唧子

第1圖，三丙  
 水圧調理器，一部  
 擴大圖

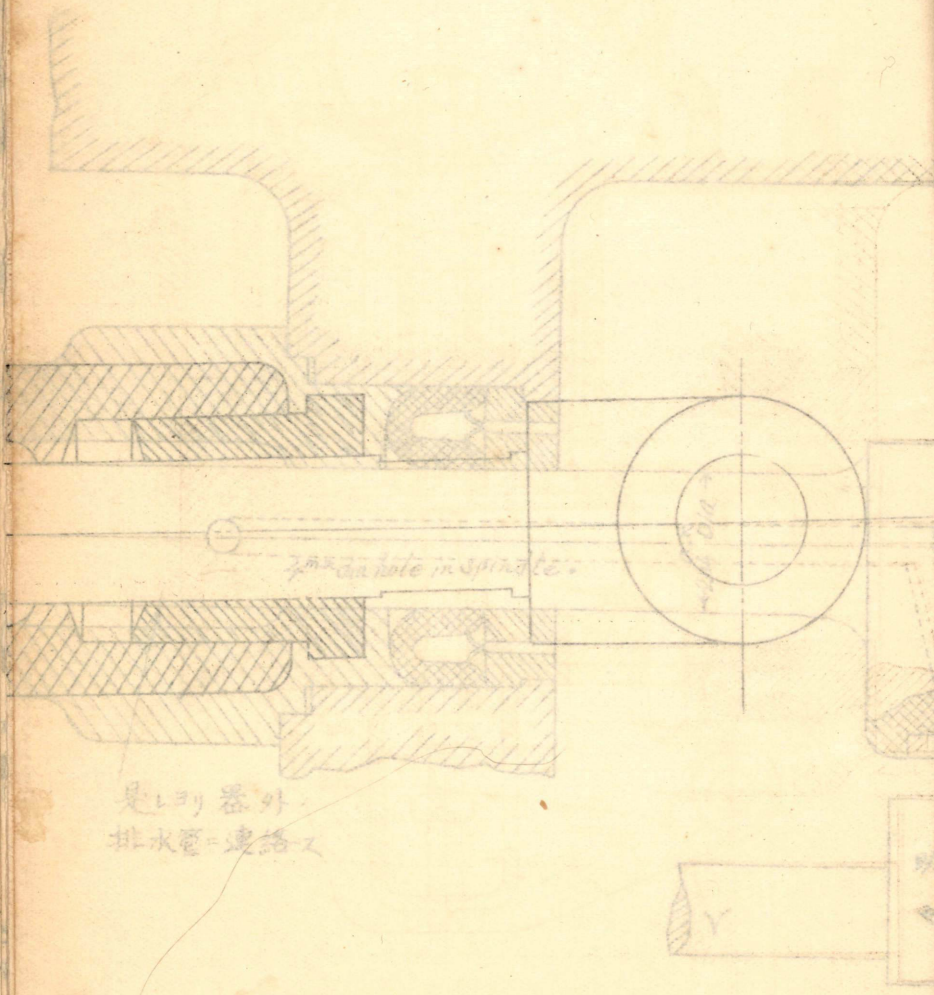

是Lの器外  
 排水管-連絡又

1 / 三丁

第1圖，三丁  
 659馬力水圧唧筒機械

鉄筒

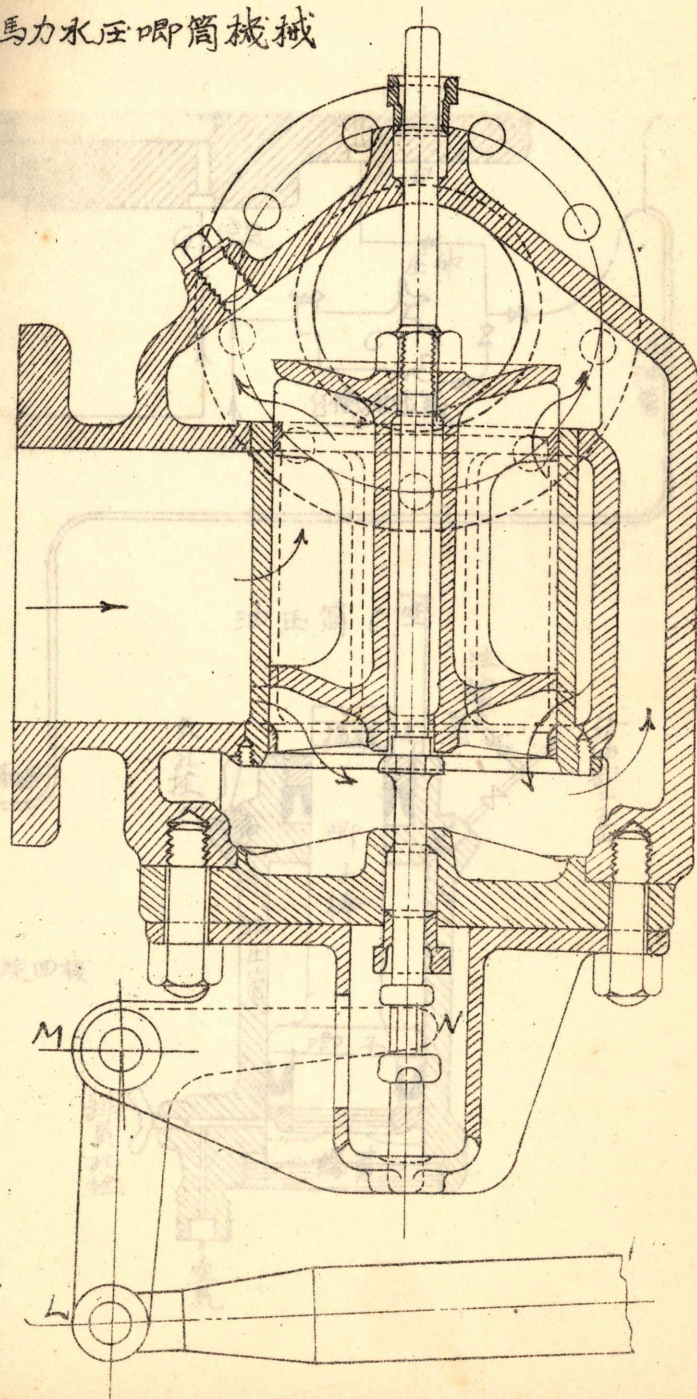



1-37

全貌

圖一 變

排水圖加五水成定P22

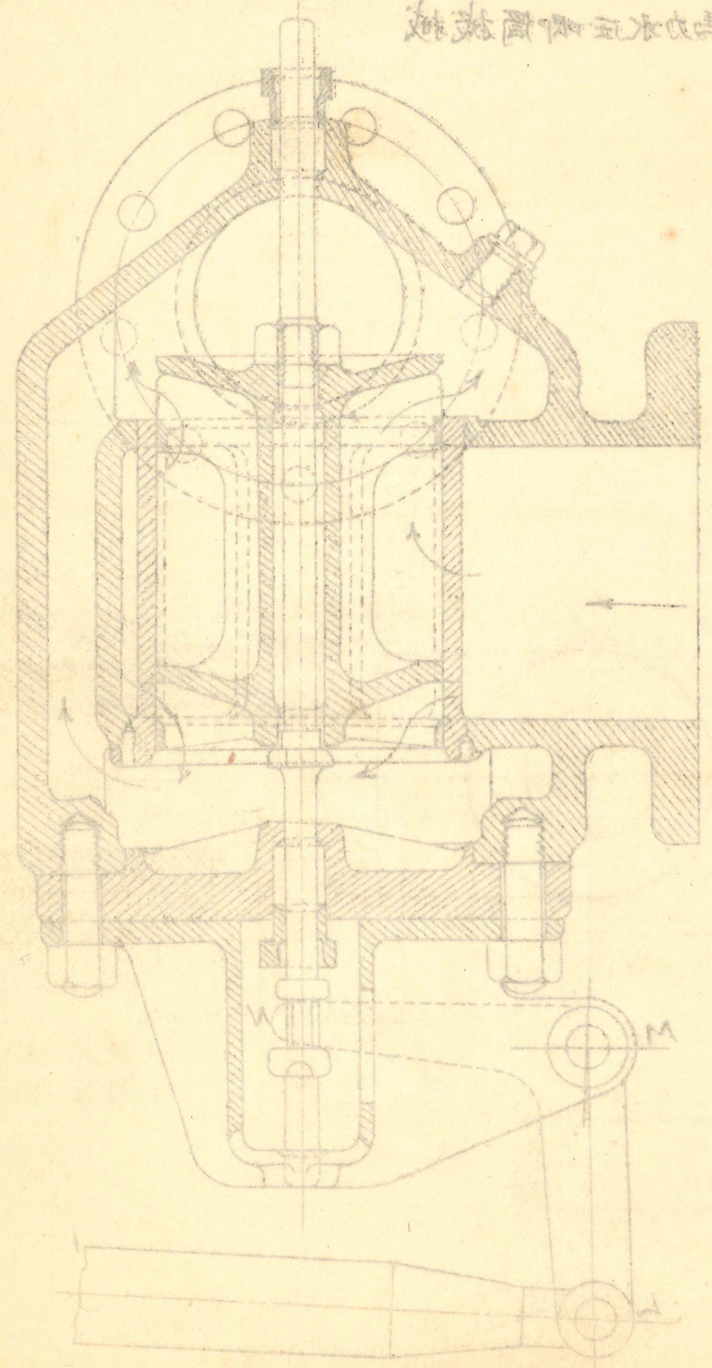

備仰部轉節管

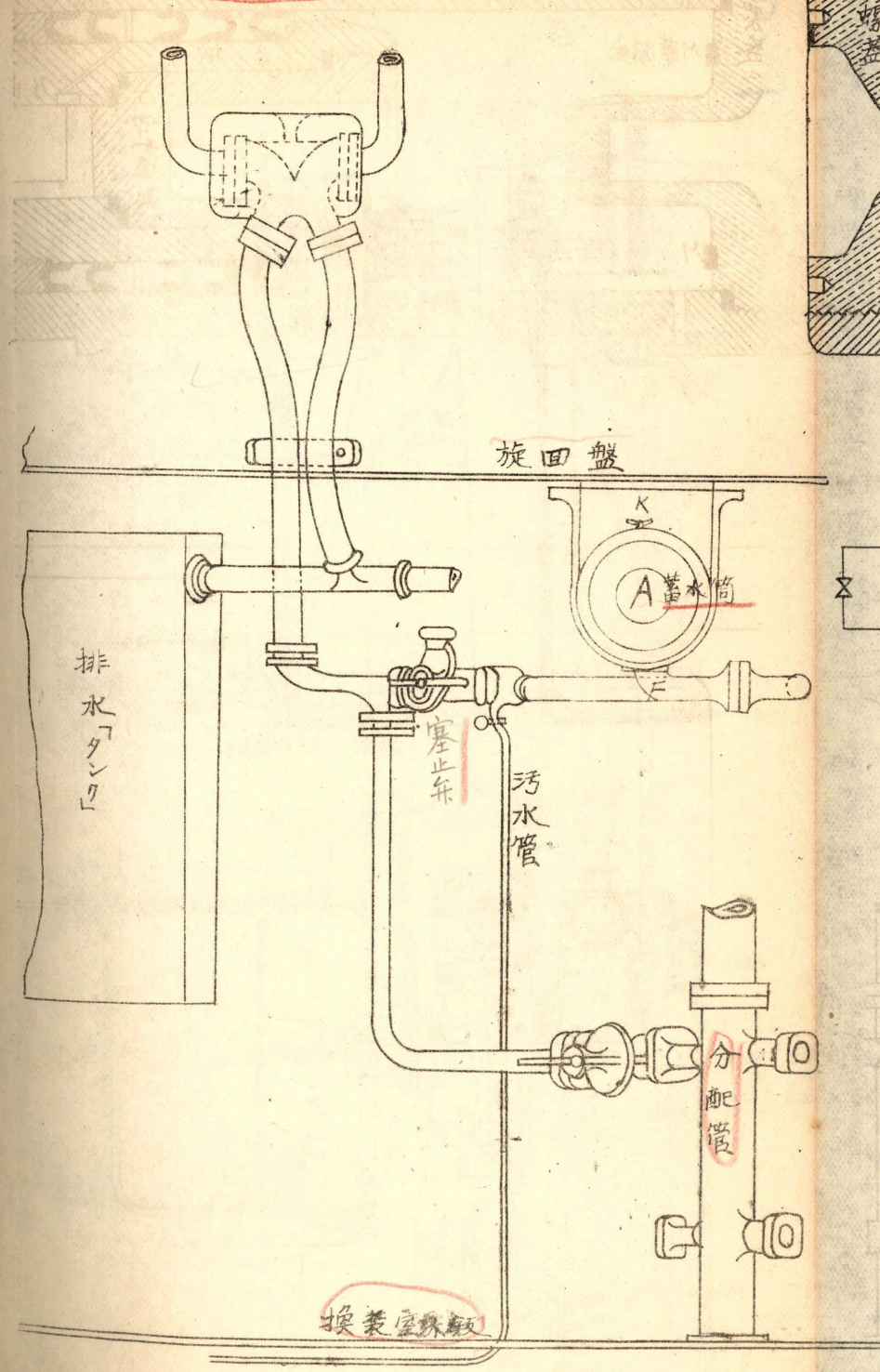

第2图  
水庄蓄勢器要領图

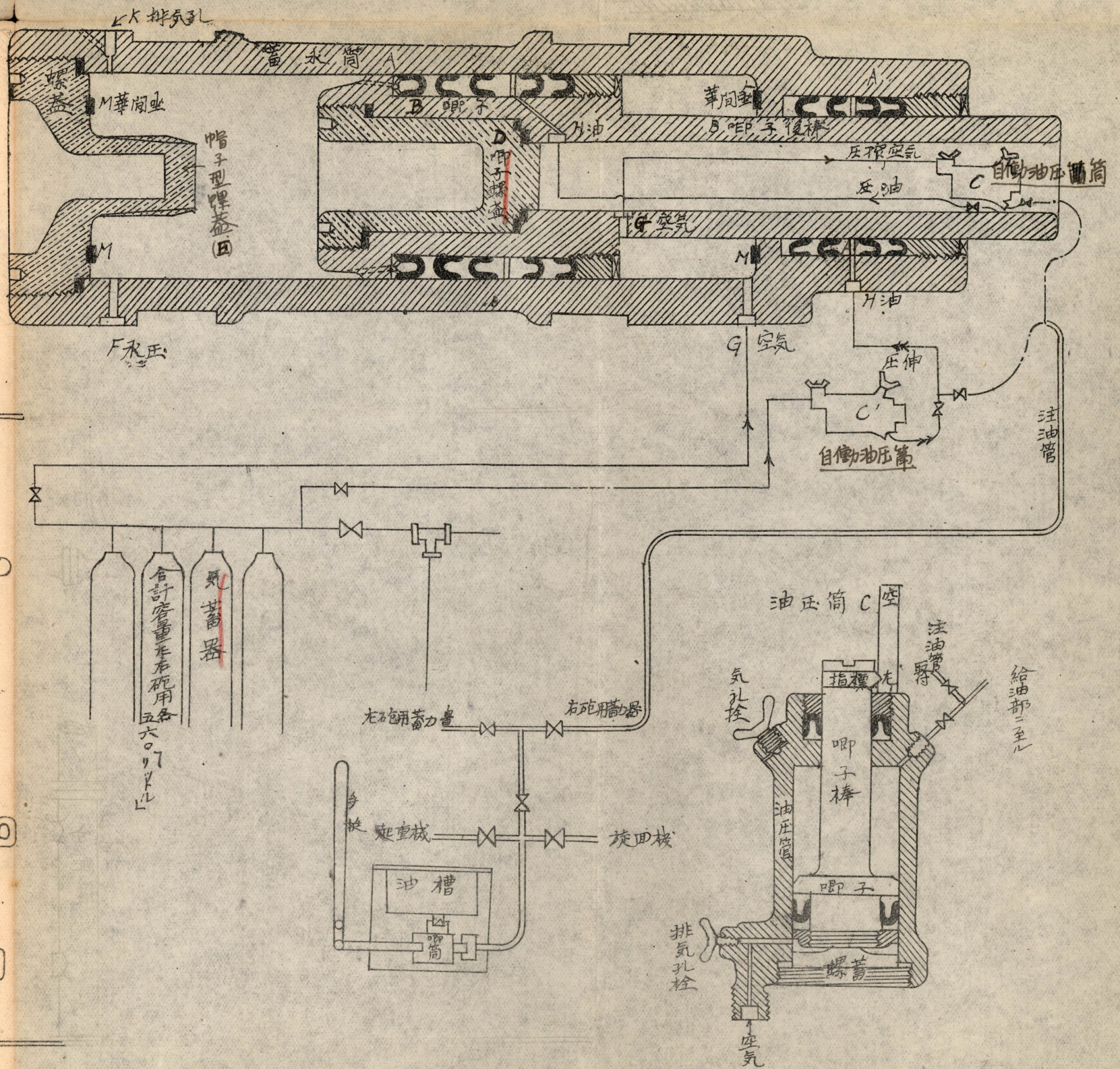
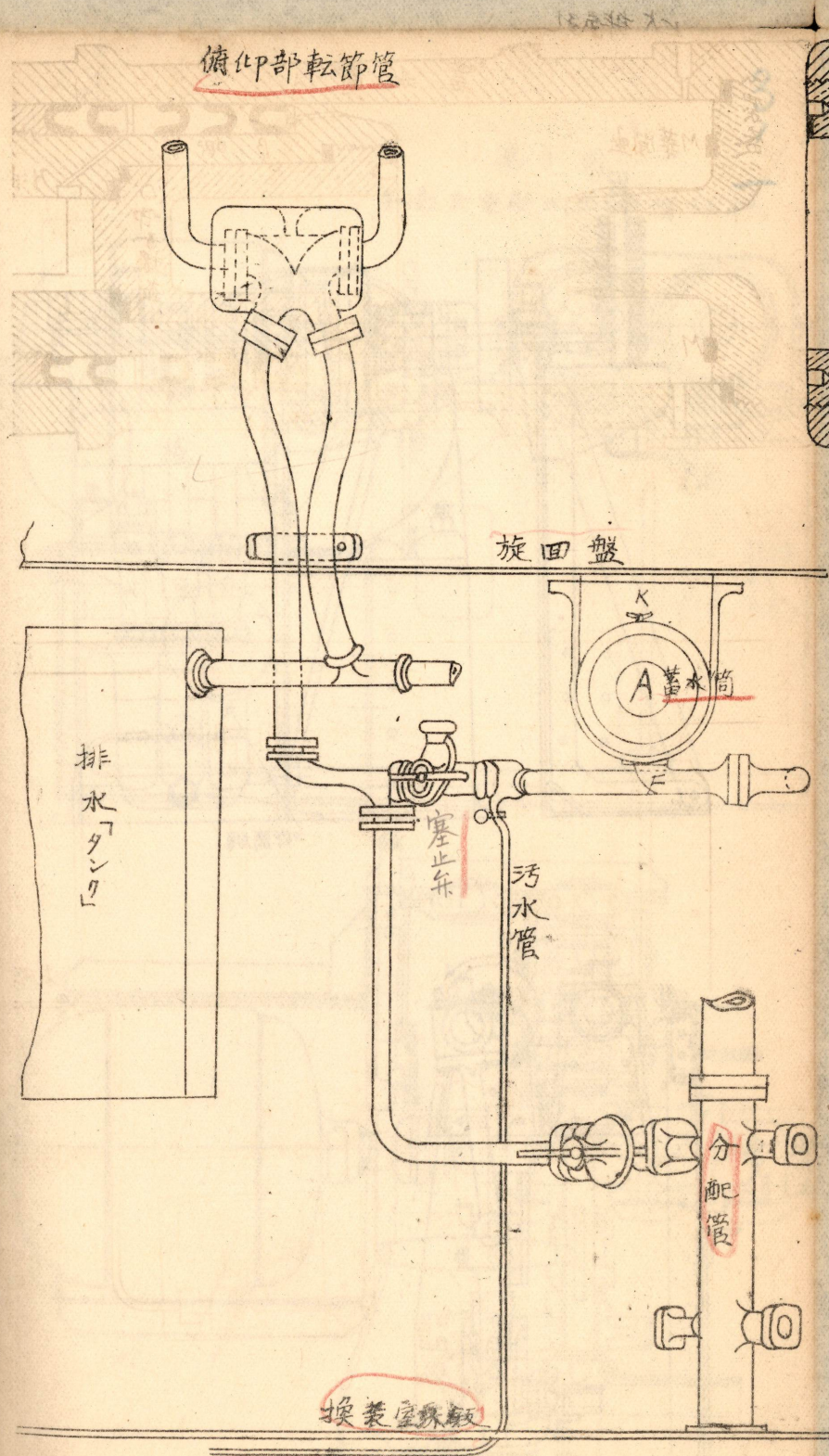

乙

第3圖

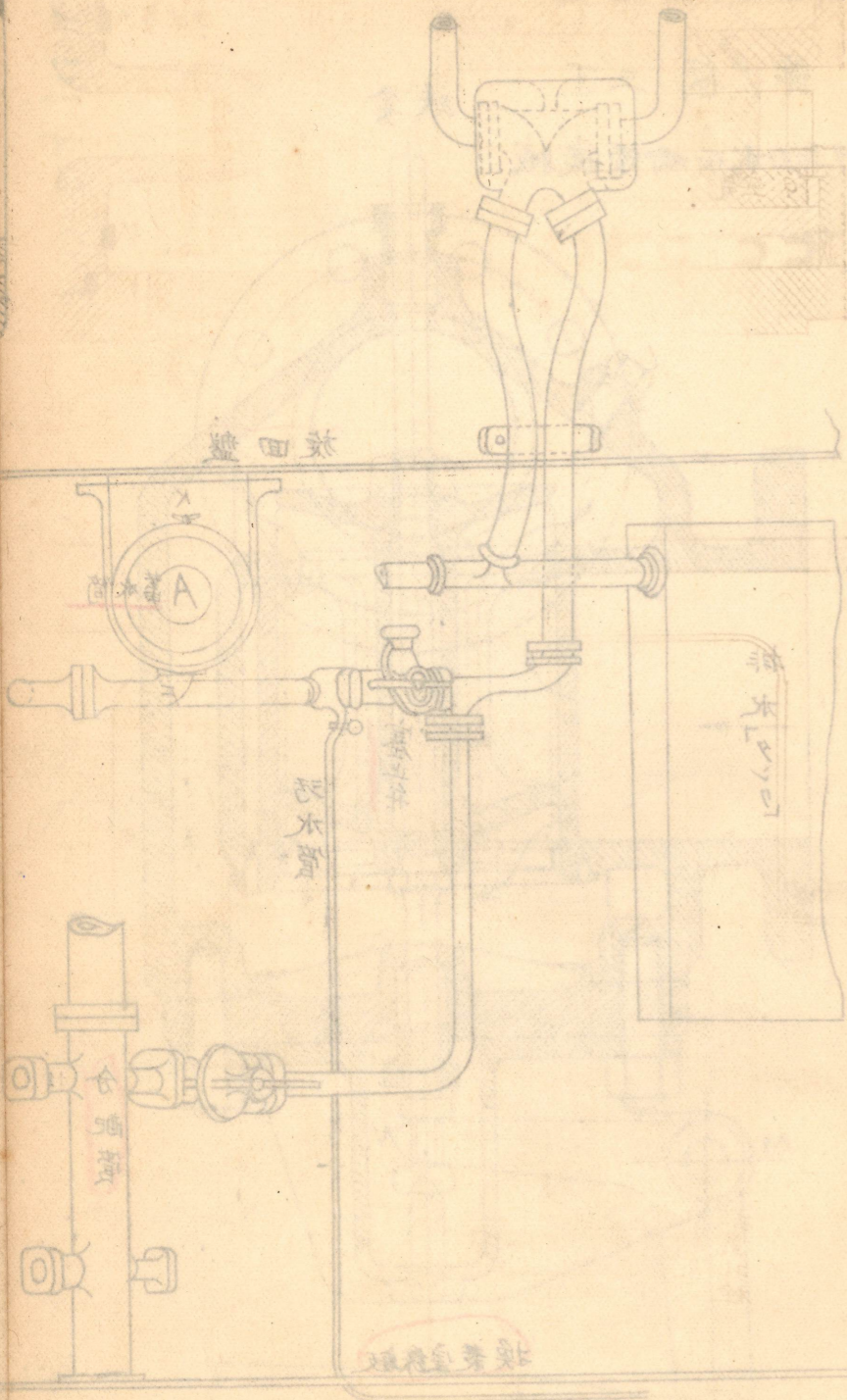

第3圖，一  
手動兼電動水壓唧筒機械

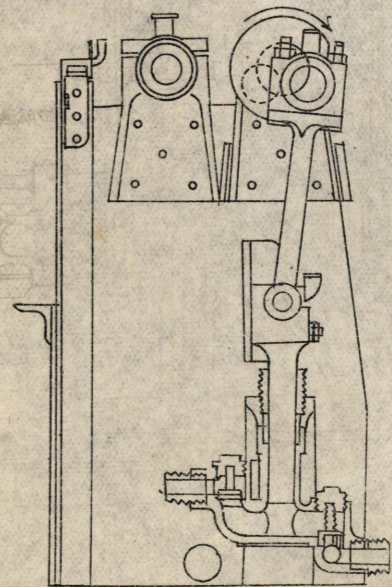
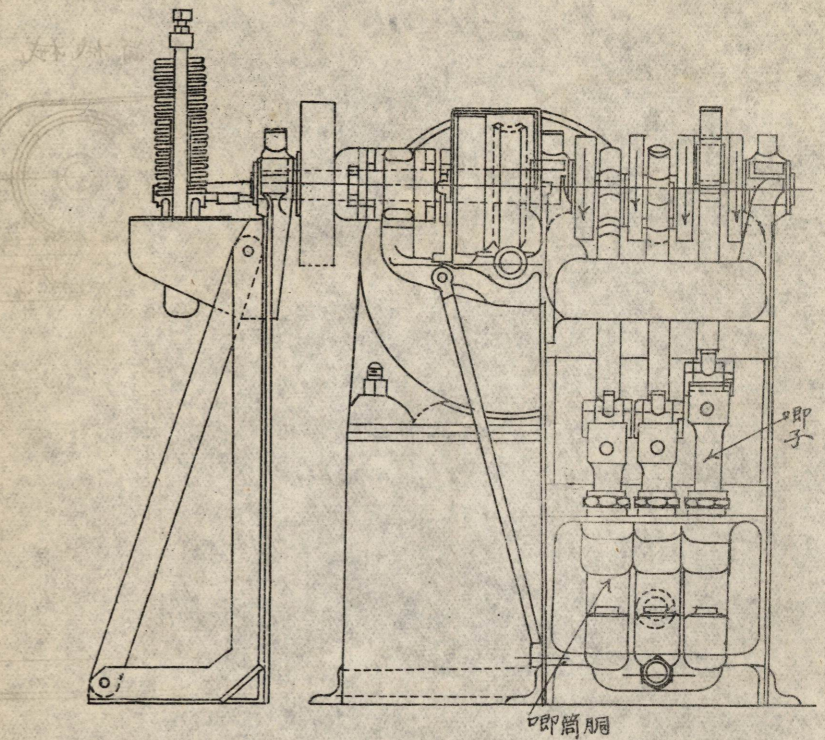
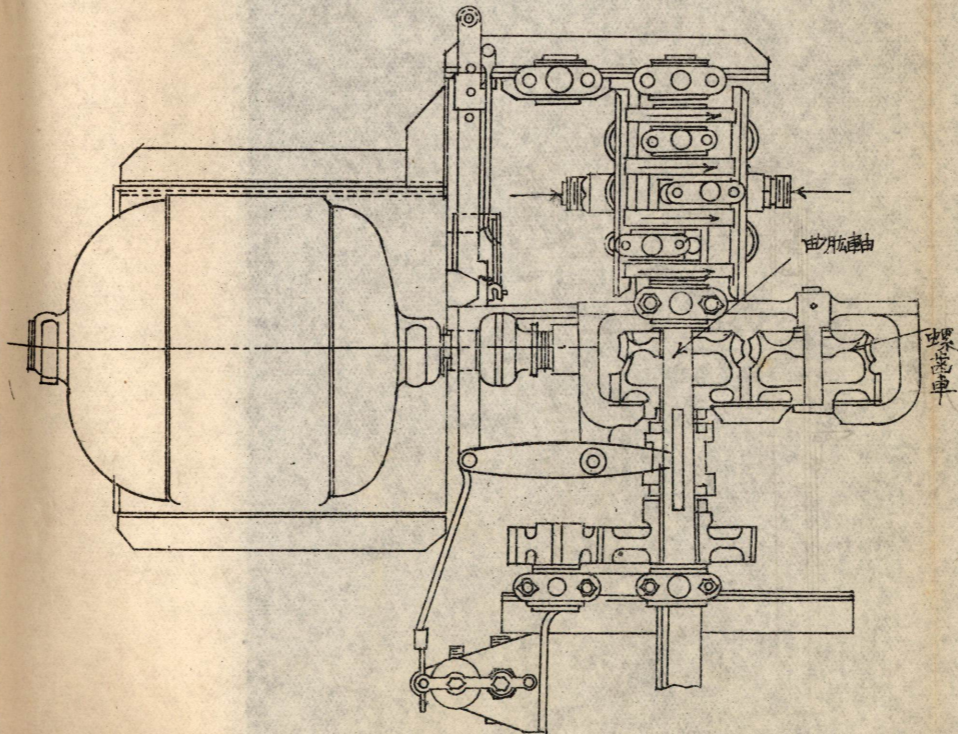
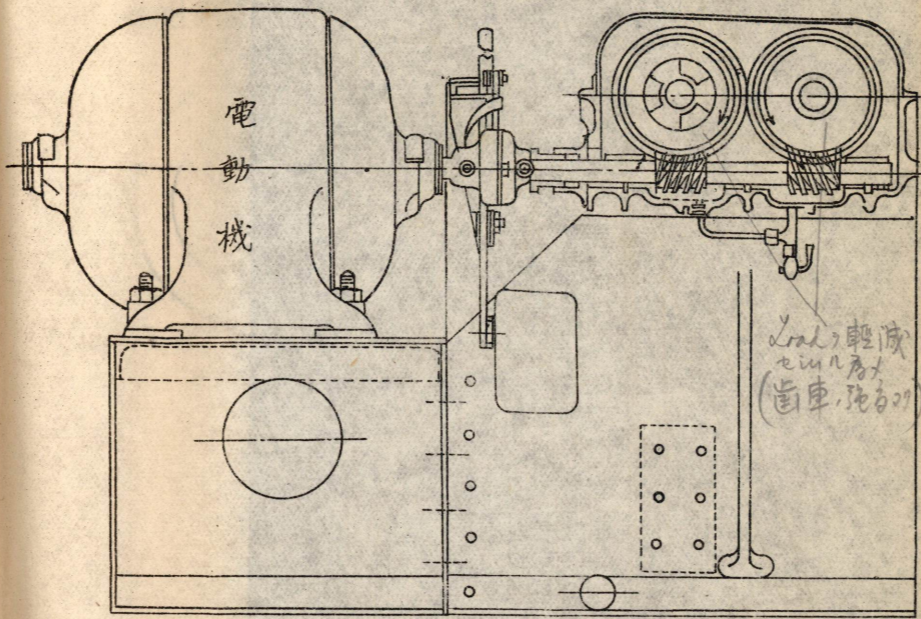

3  
1

圖 1  
三曲肱水壓唧筒機

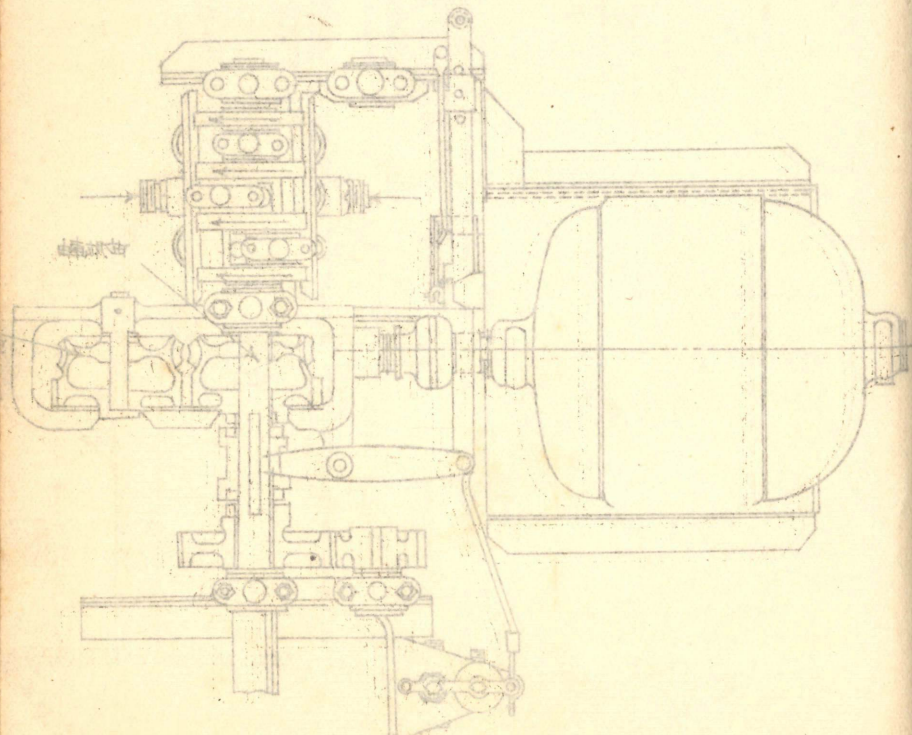
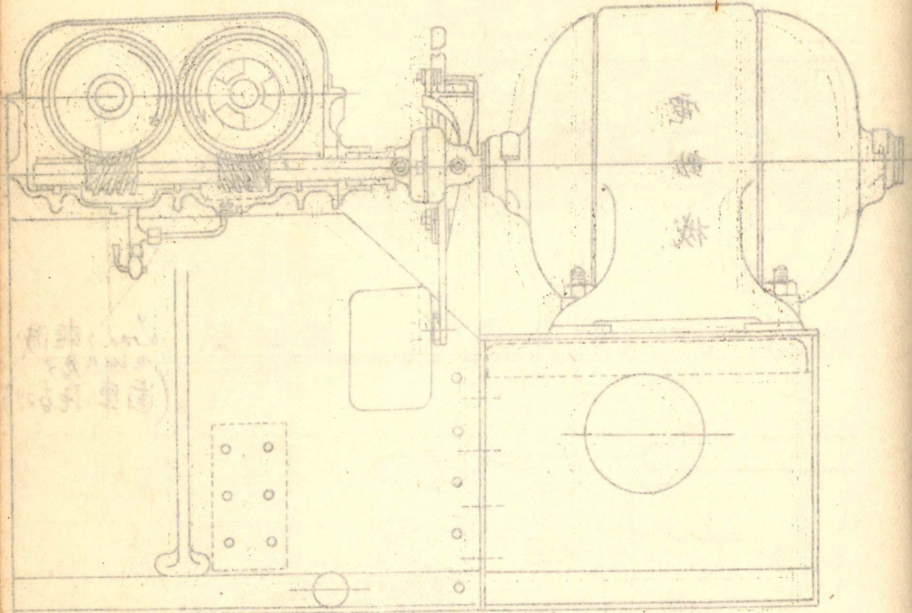

緩衝用空氣室

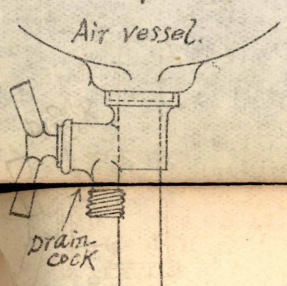

第 3 圖 二  
電動唧筒用水壓調節器

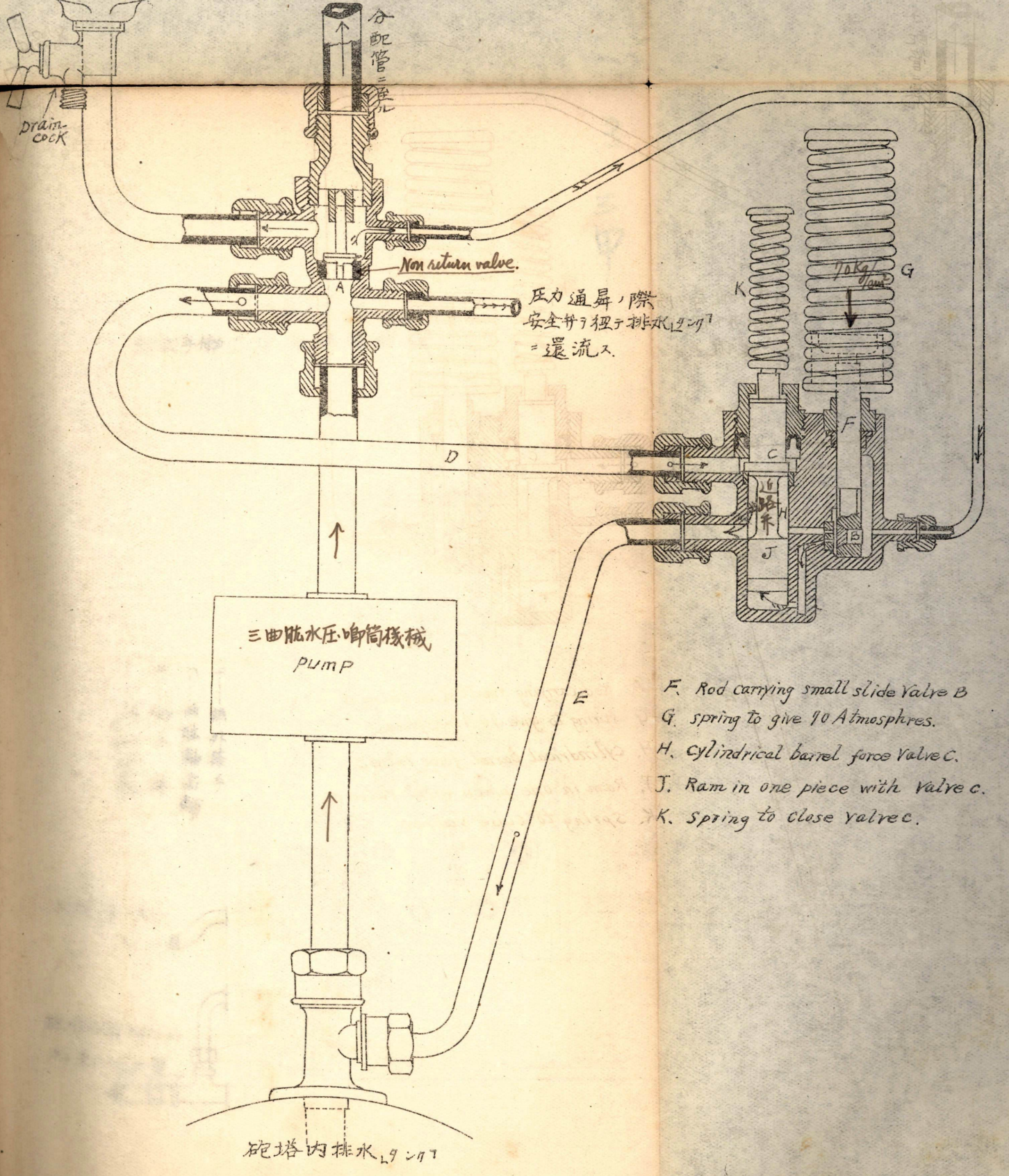

壓力通昇，際  
安全弁ヲ徑テ排水シテ  
= 還流入。

- F. Rod carrying small slide Valve B
- G. spring to give 10 Atmospheres.
- H. cylindrical barrel force Valve C.
- J. Ram in one piece with Valve C.
- K. Spring to close valve C.

砲塔内排水

1-3

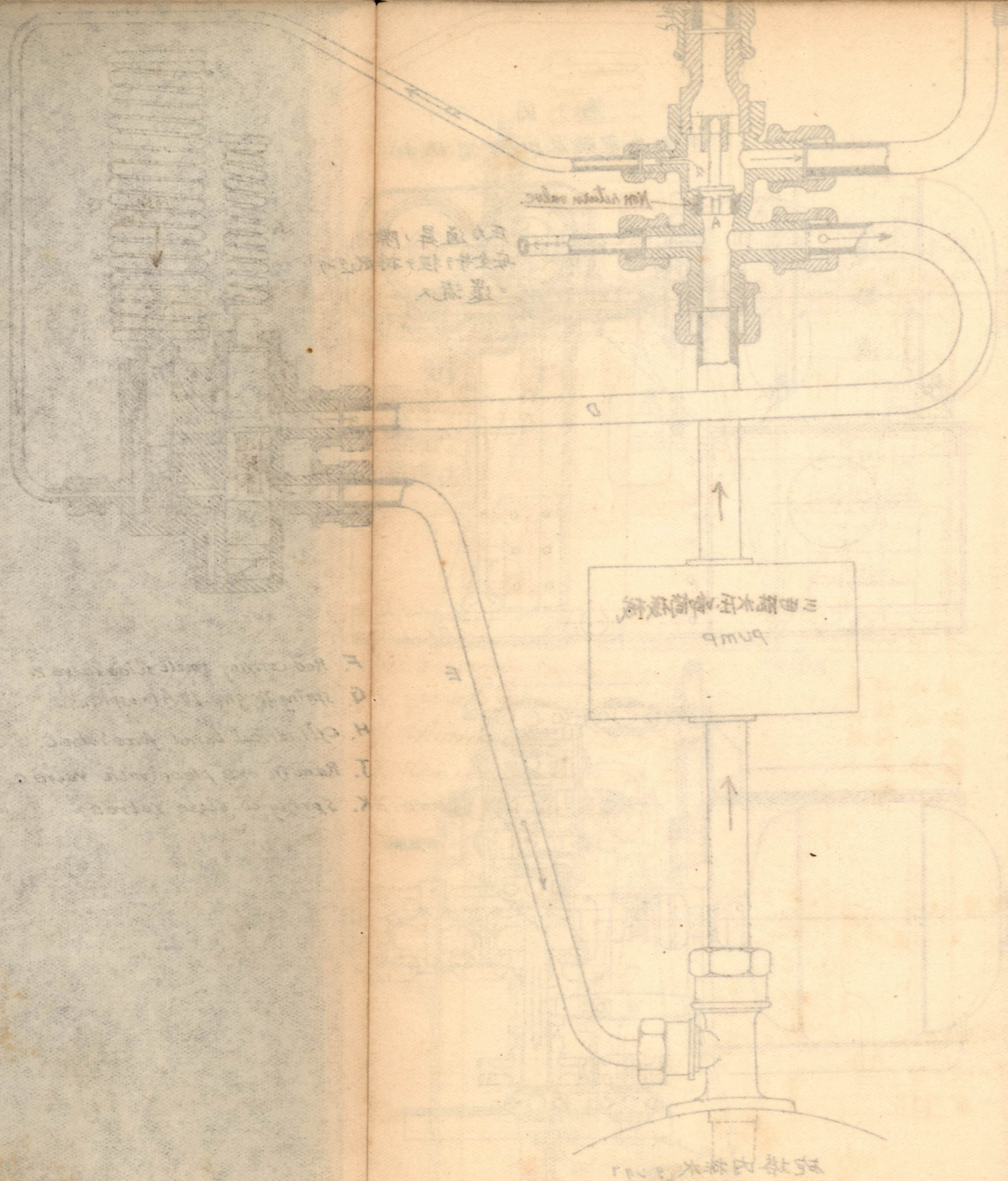

第3圖(三)甲  
新式手動兼電動唧筒機械

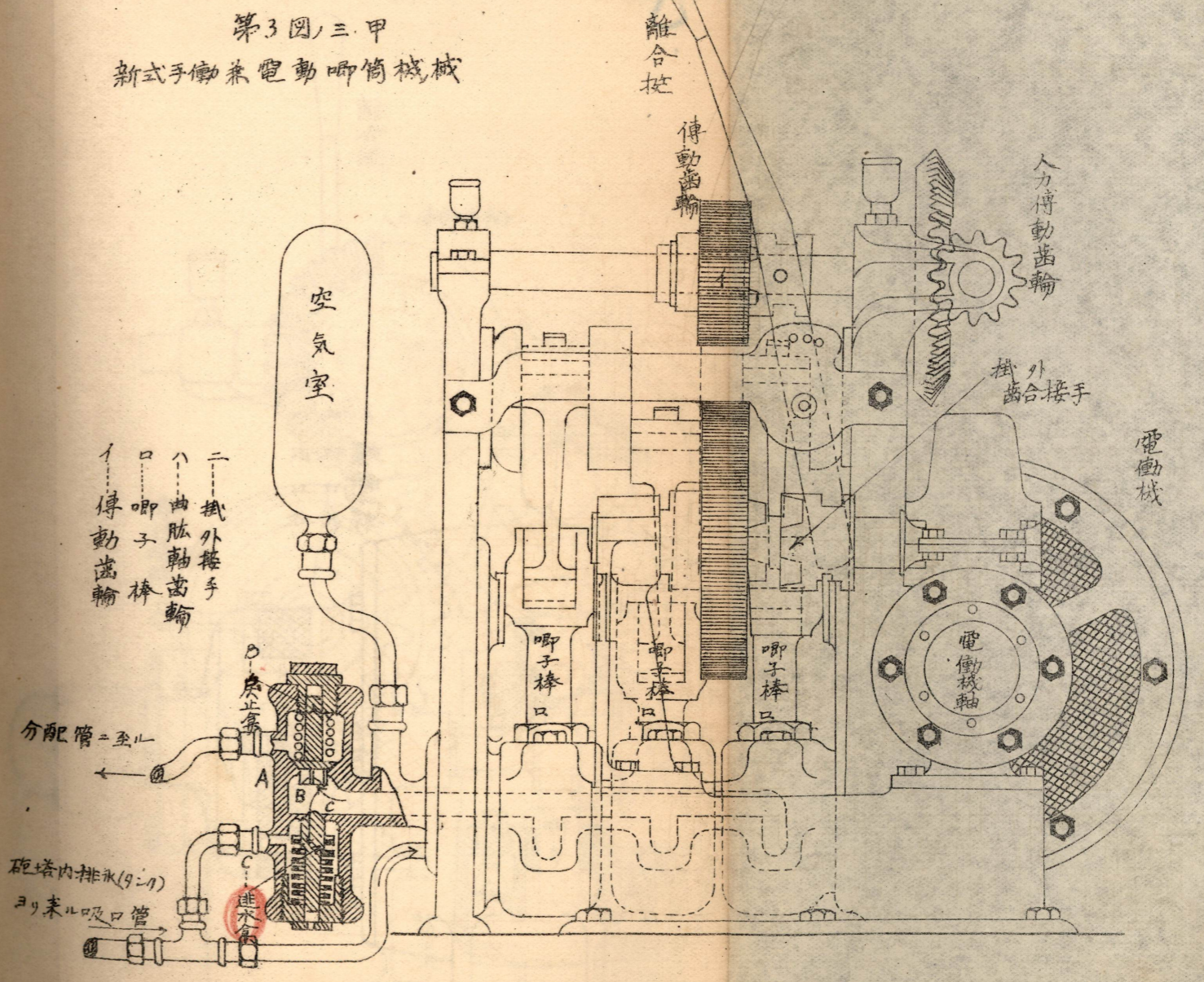

313甲

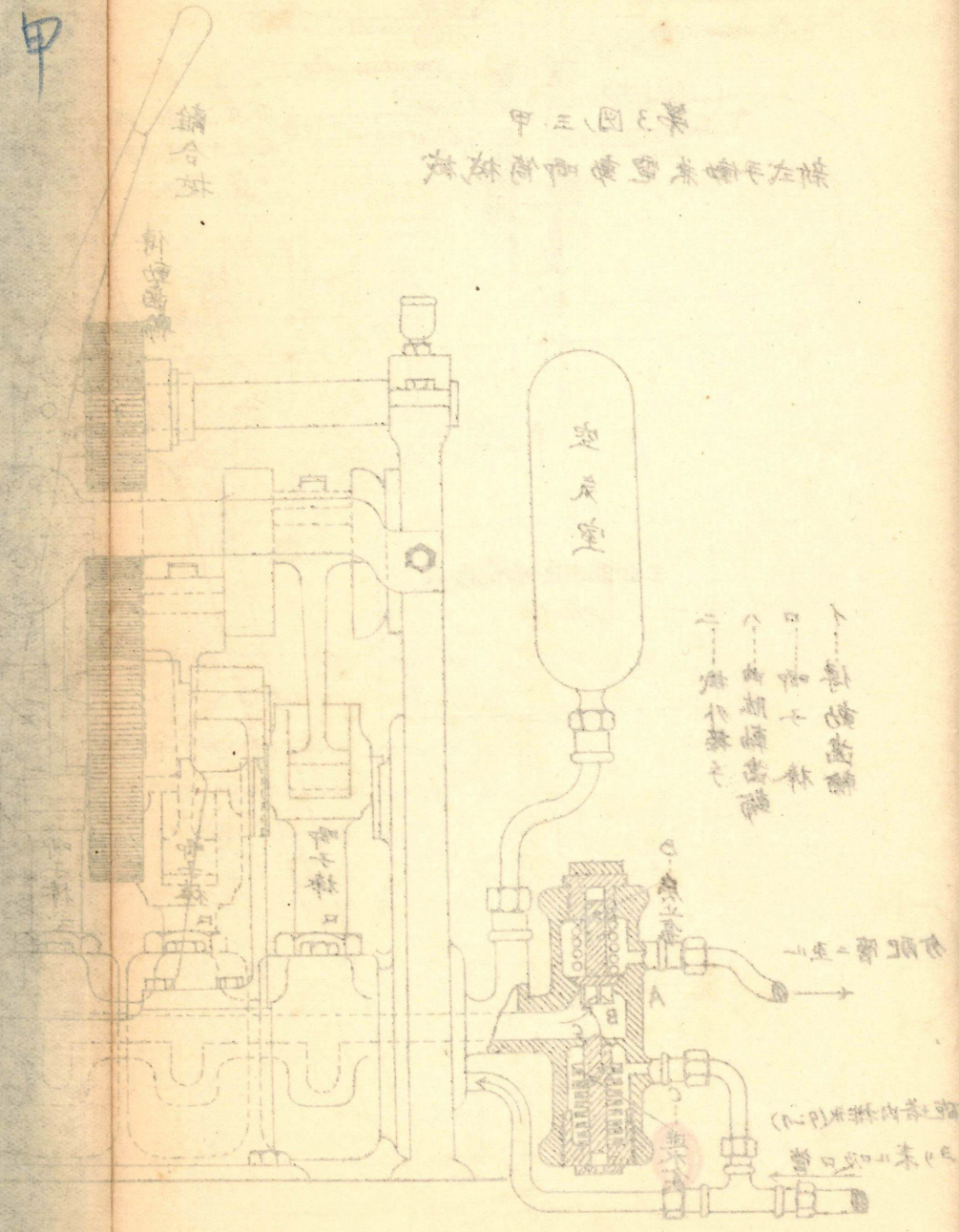

第3圖, 三, 乙  
新式電動兼手動唧筒機械

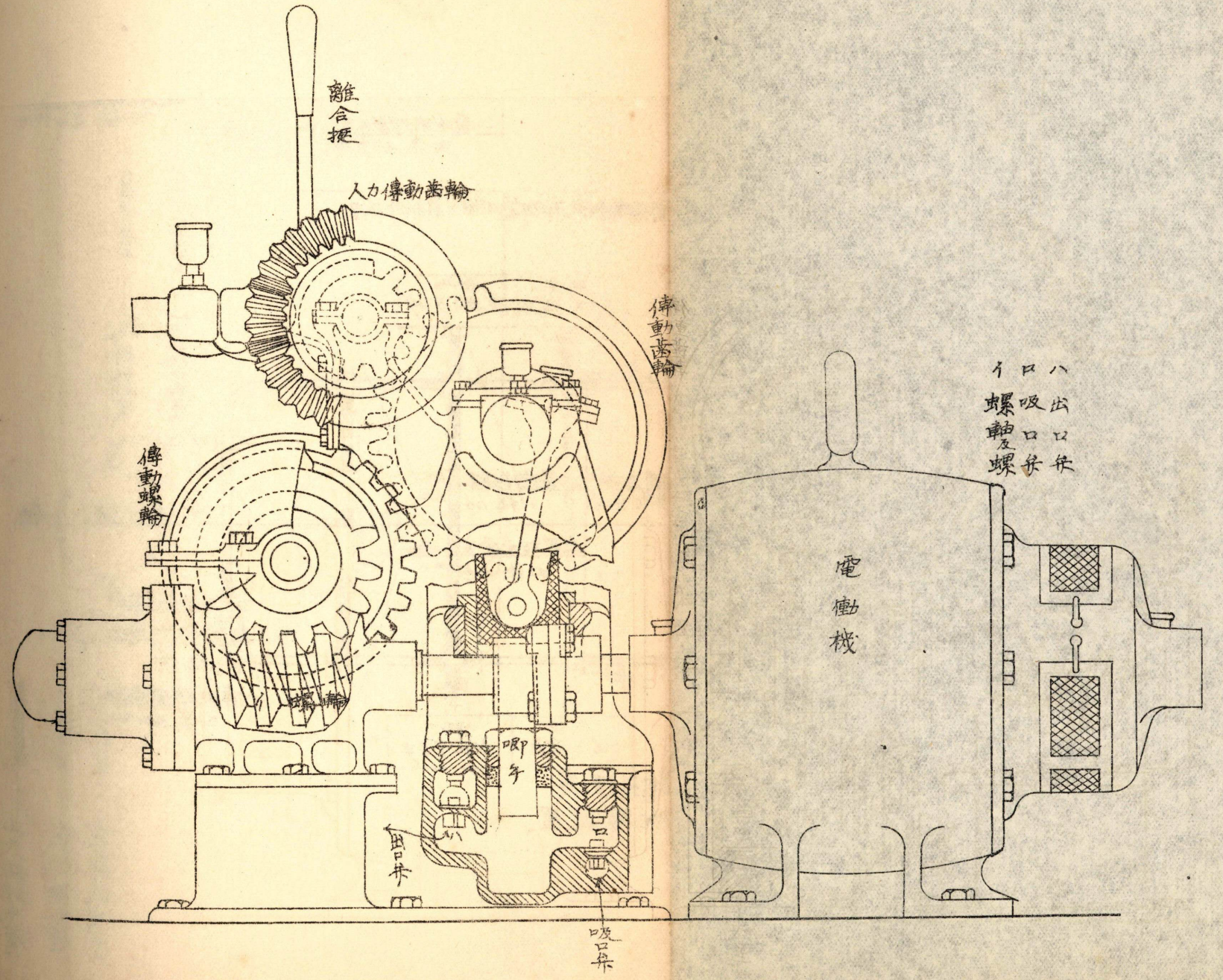

号  
三  
乙

图 6 第  
弹壳退壳机构

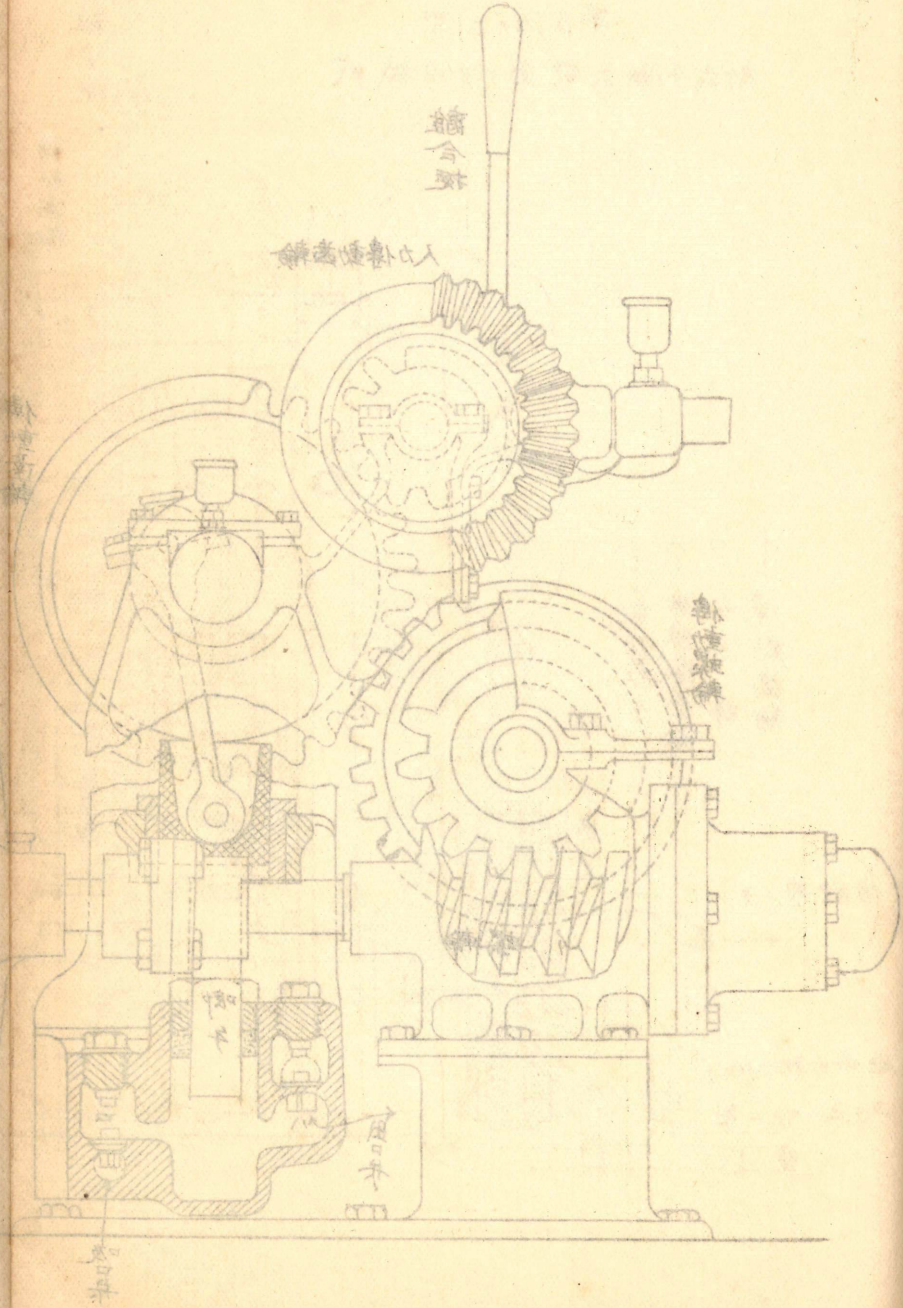

四番砲塔彈庫  
内徑 45

艇

後

艇

四番

第4圖(一)  
軍艦陸奧水壓管裝置

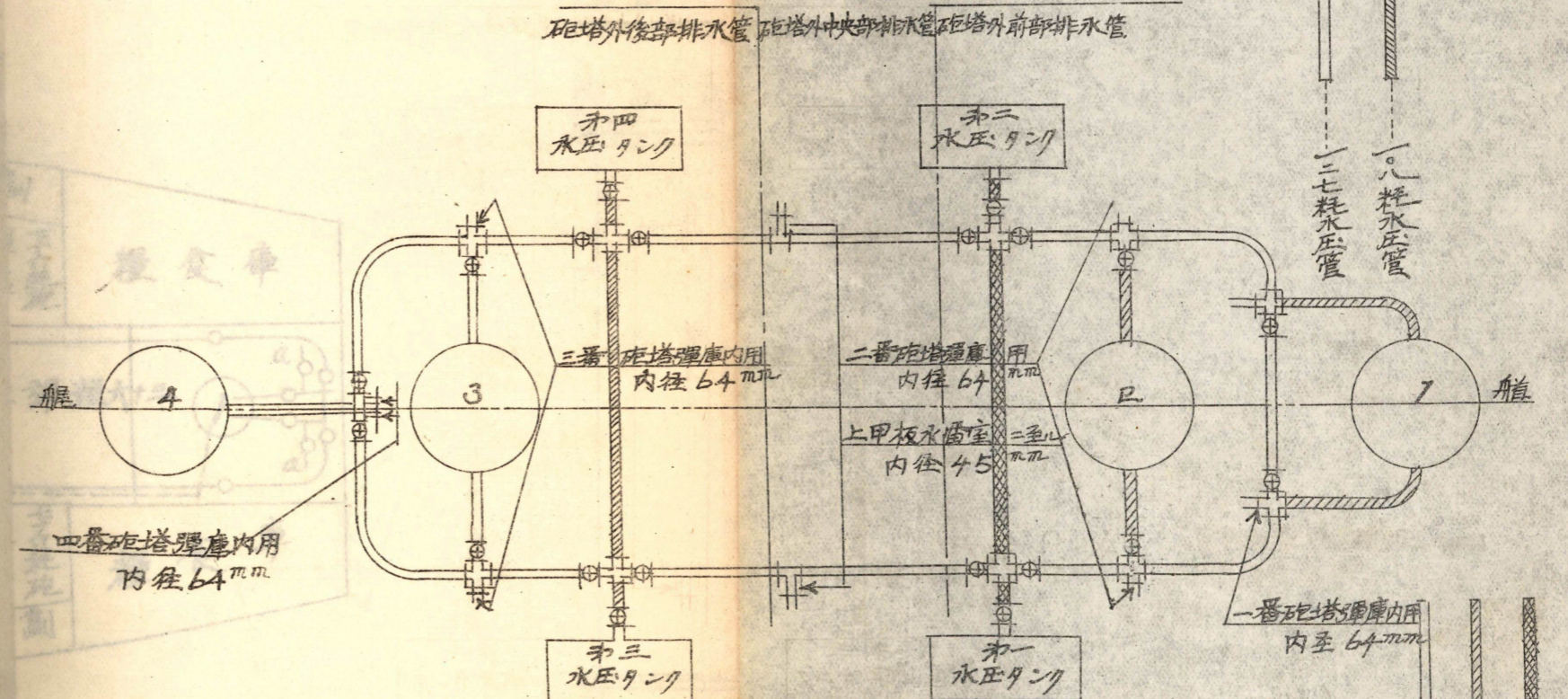
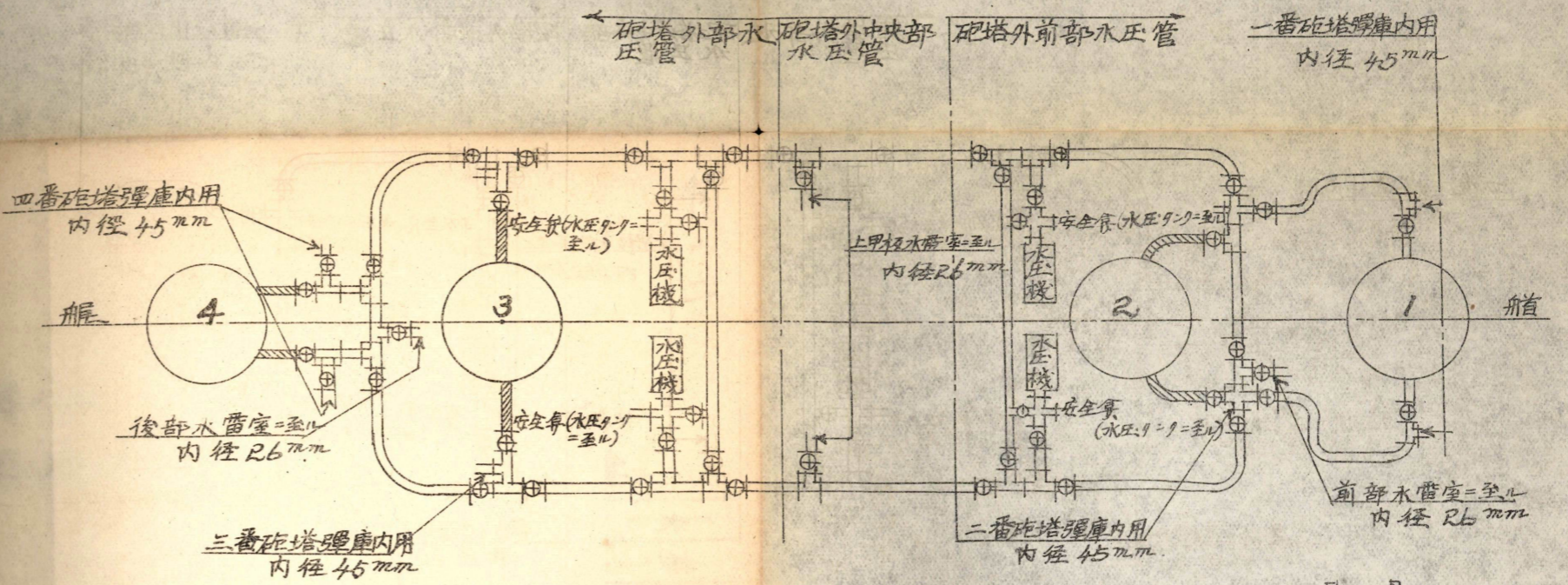

軍艦陸奧  
排水管裝置

三、圖(二)  
軍艦陸奧水壓管裝置

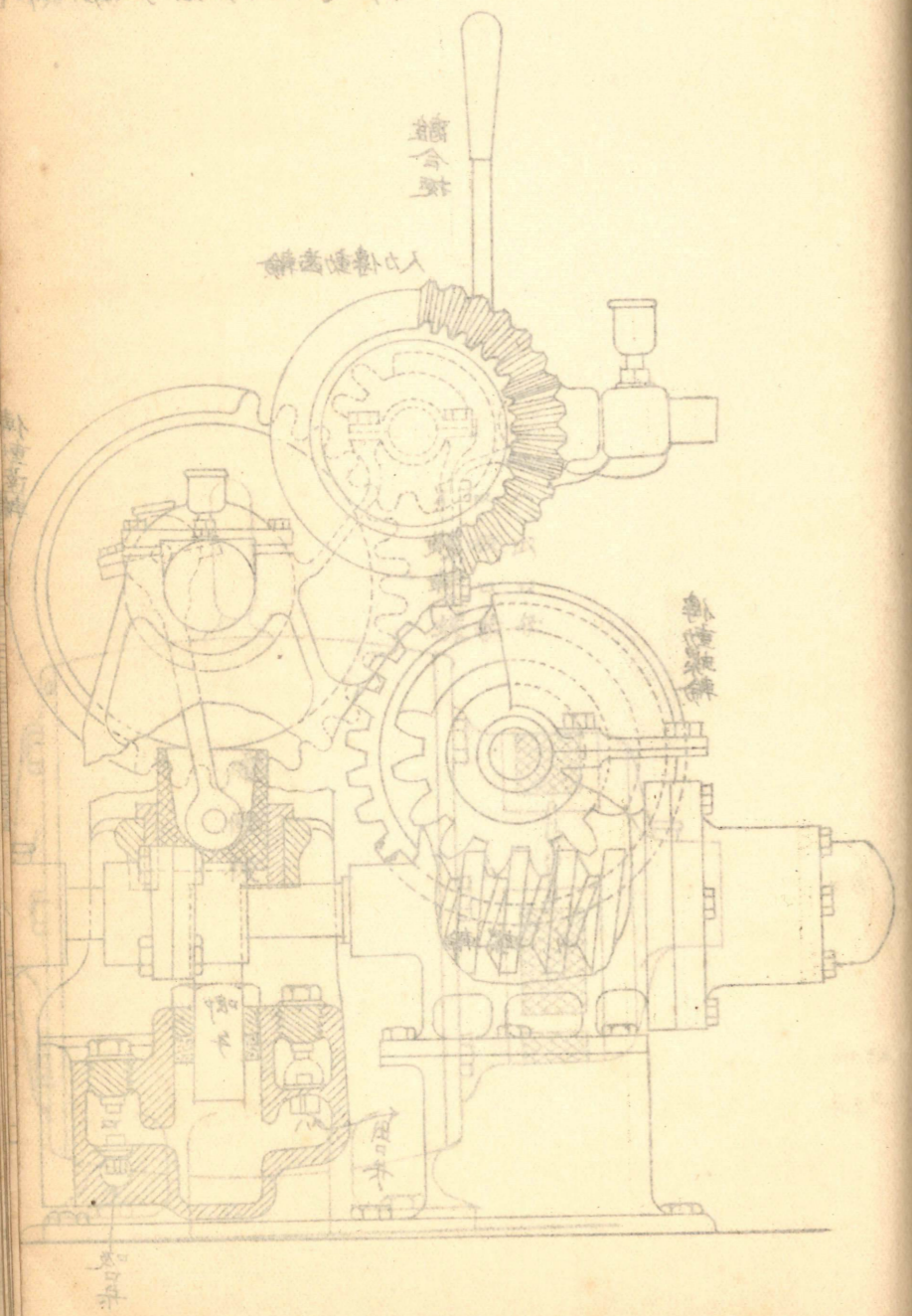



4  
1

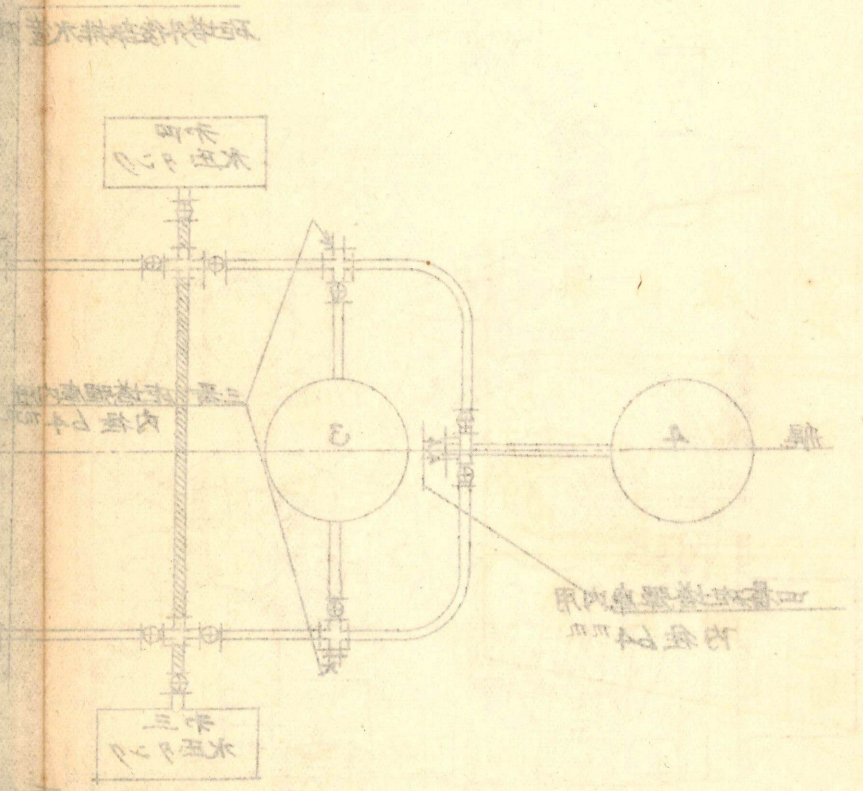
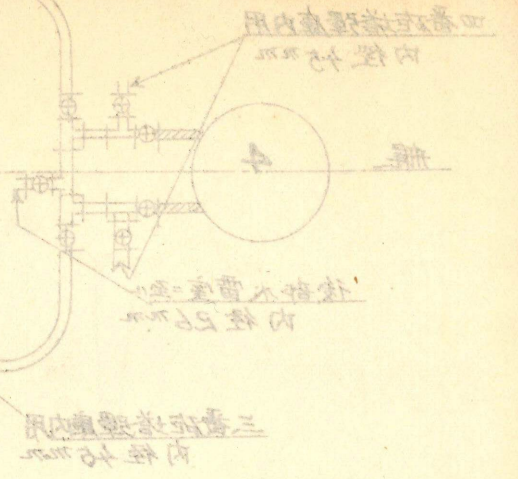

基本图

軍艦比叡砲塔外水圧

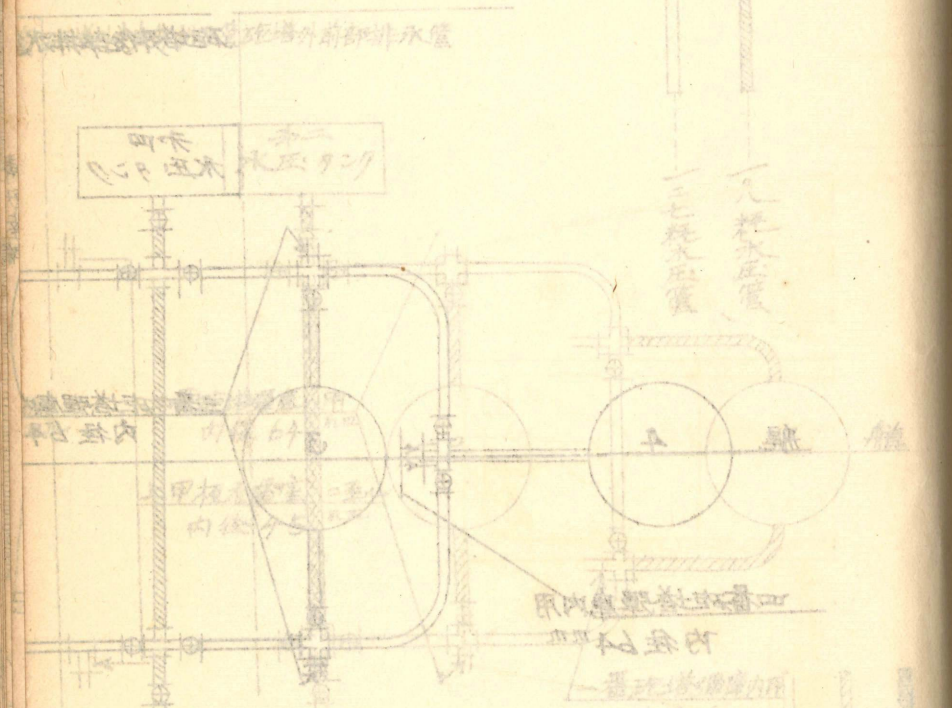
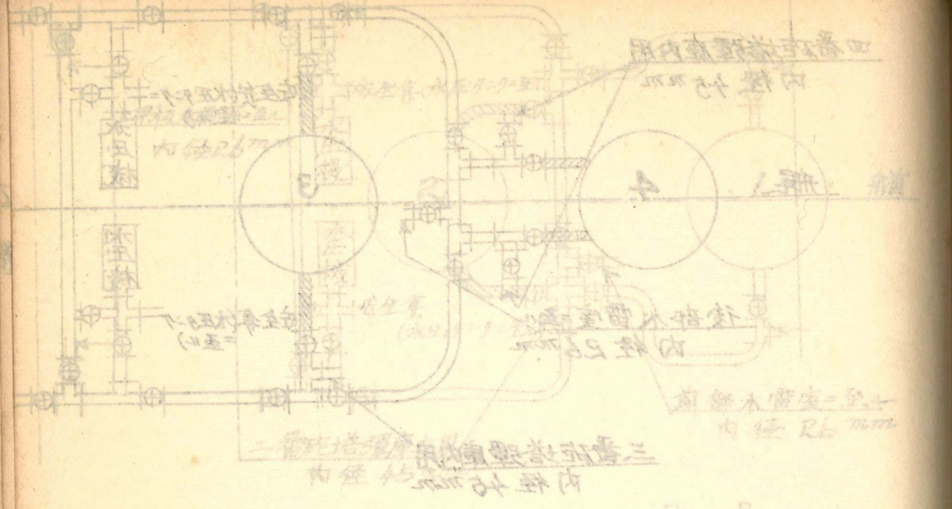
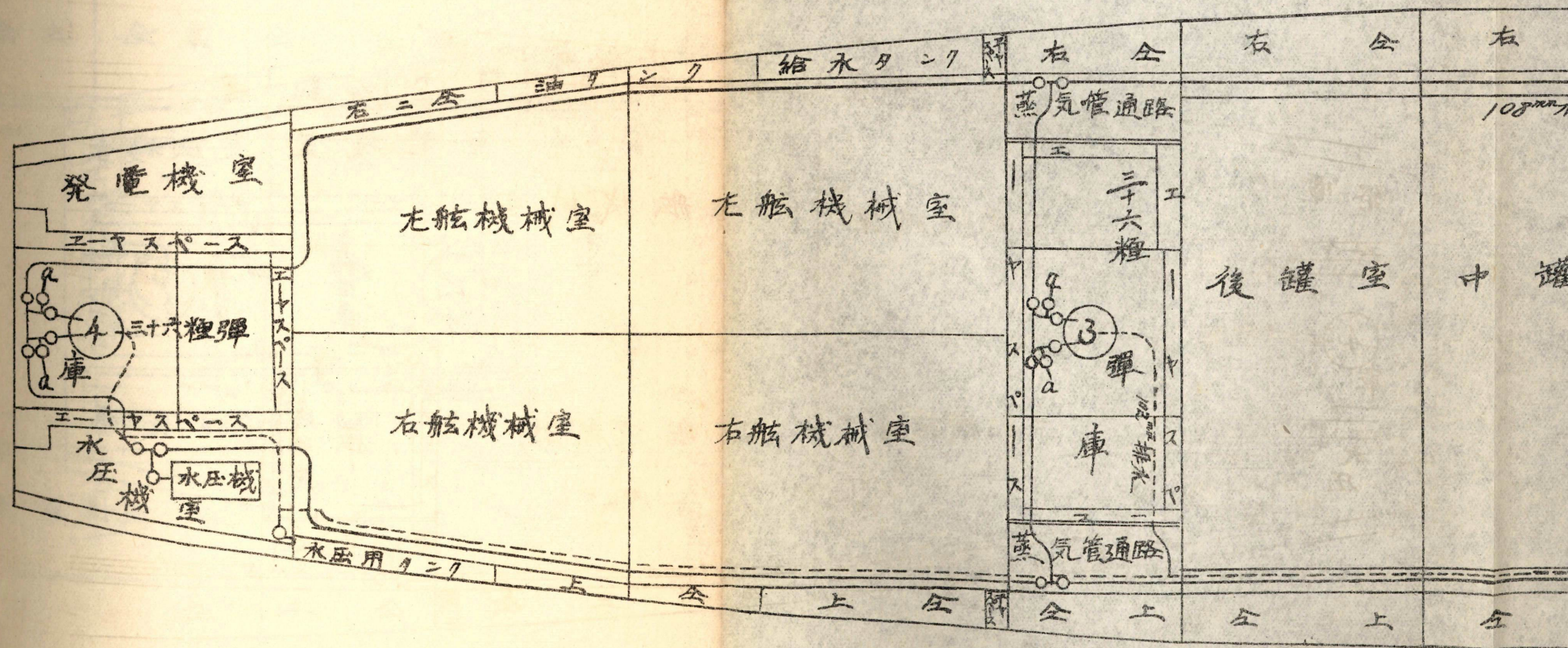

三六糧庫  
 水圧機  
 水圧用タンク  
 彈庫  
 水圧機  
 水圧用タンク  
 三六糧庫  
 彈庫  
 水圧機  
 水圧用タンク

第4圖，二

軍艦比叻砲塔外水压及排水管之圖

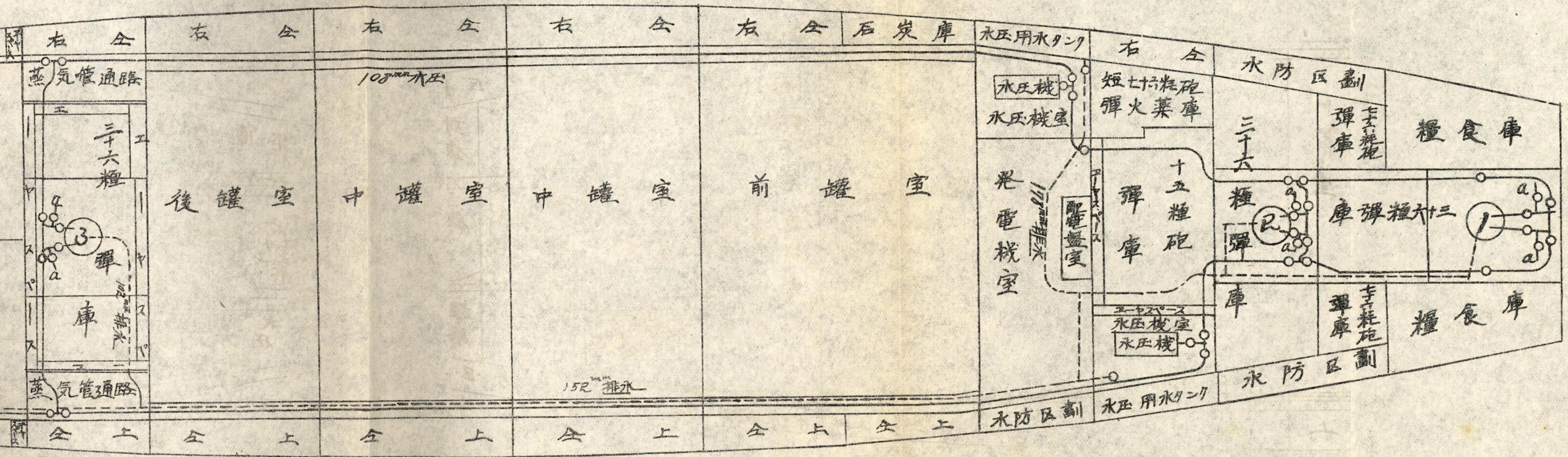
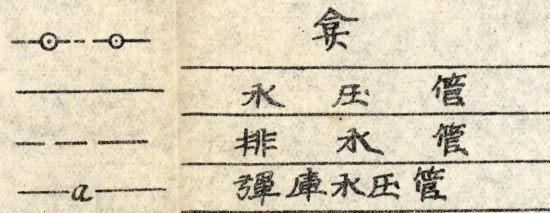

一、四、十  
圖一、圖二、圖三、圖四、圖五、圖六、圖七、圖八、圖九、圖十



軍艦比叡砲塔外

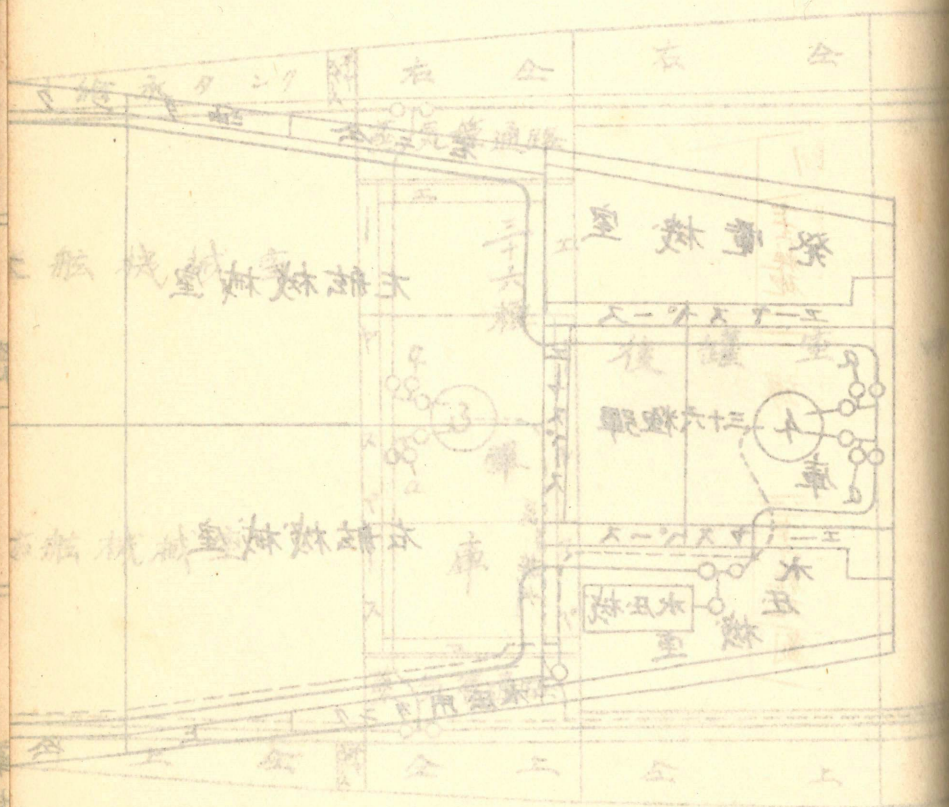

一試發力...  
組立時  
分組時  
裝置

第4圖, 三

軍艦山城砲塔外水圧

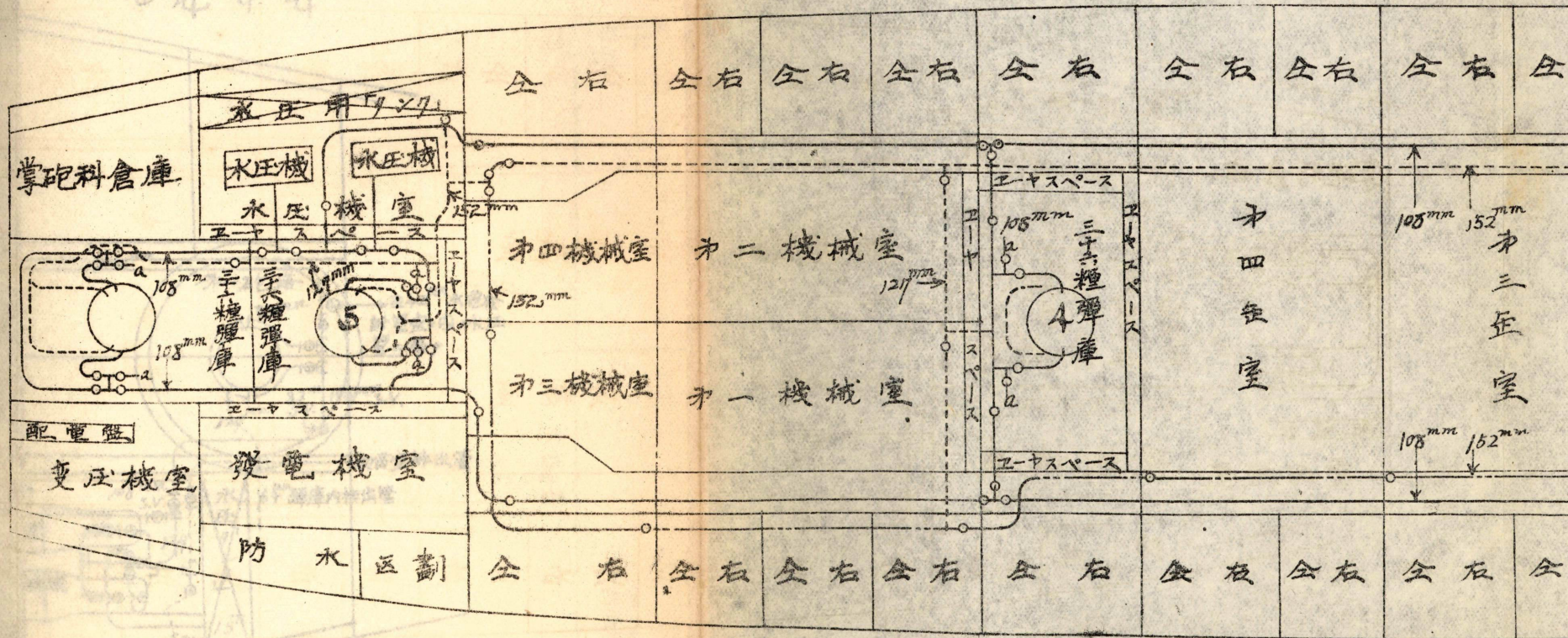

第4图, 三

軍艦山城砲塔外水圧及排水管之図

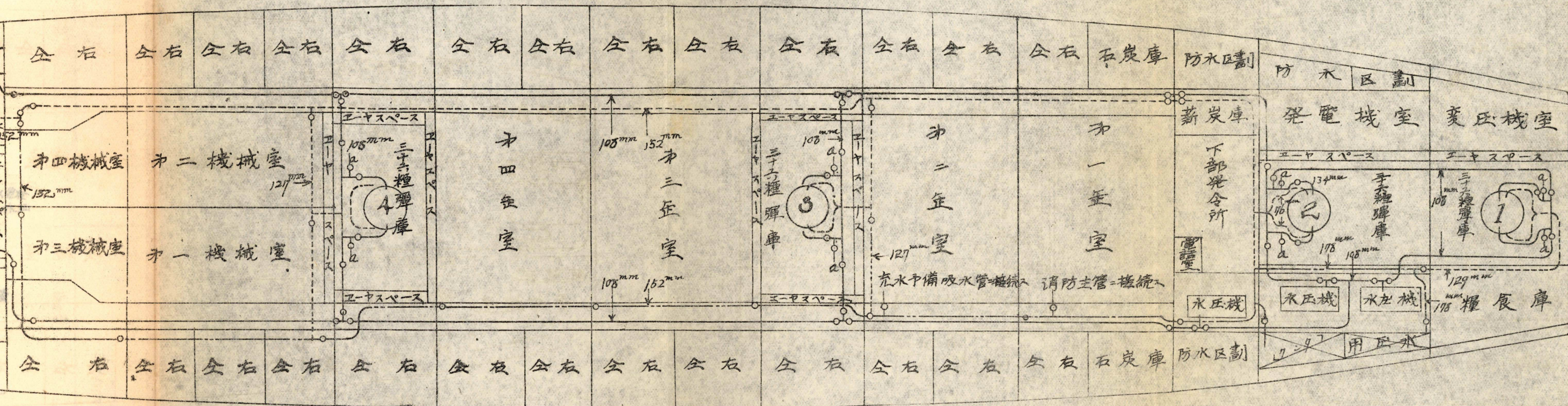
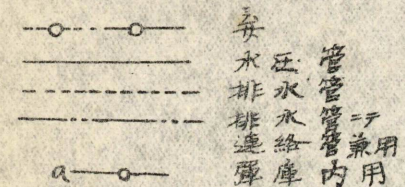

4  
三

廣雅釋詁卷之四

<p>廣雅釋詁卷之四</p>	<p>廣雅釋詁卷之四</p>	<p>廣雅釋詁卷之四</p>	<p>廣雅釋詁卷之四</p>	<p>廣雅釋詁卷之四</p>	<p>廣雅釋詁卷之四</p>	<p>廣雅釋詁卷之四</p>
<p>廣雅釋詁卷之四</p>	<p>廣雅釋詁卷之四</p>	<p>廣雅釋詁卷之四</p>	<p>廣雅釋詁卷之四</p>	<p>廣雅釋詁卷之四</p>	<p>廣雅釋詁卷之四</p>	<p>廣雅釋詁卷之四</p>