

第四十三图

三六式縱舵機

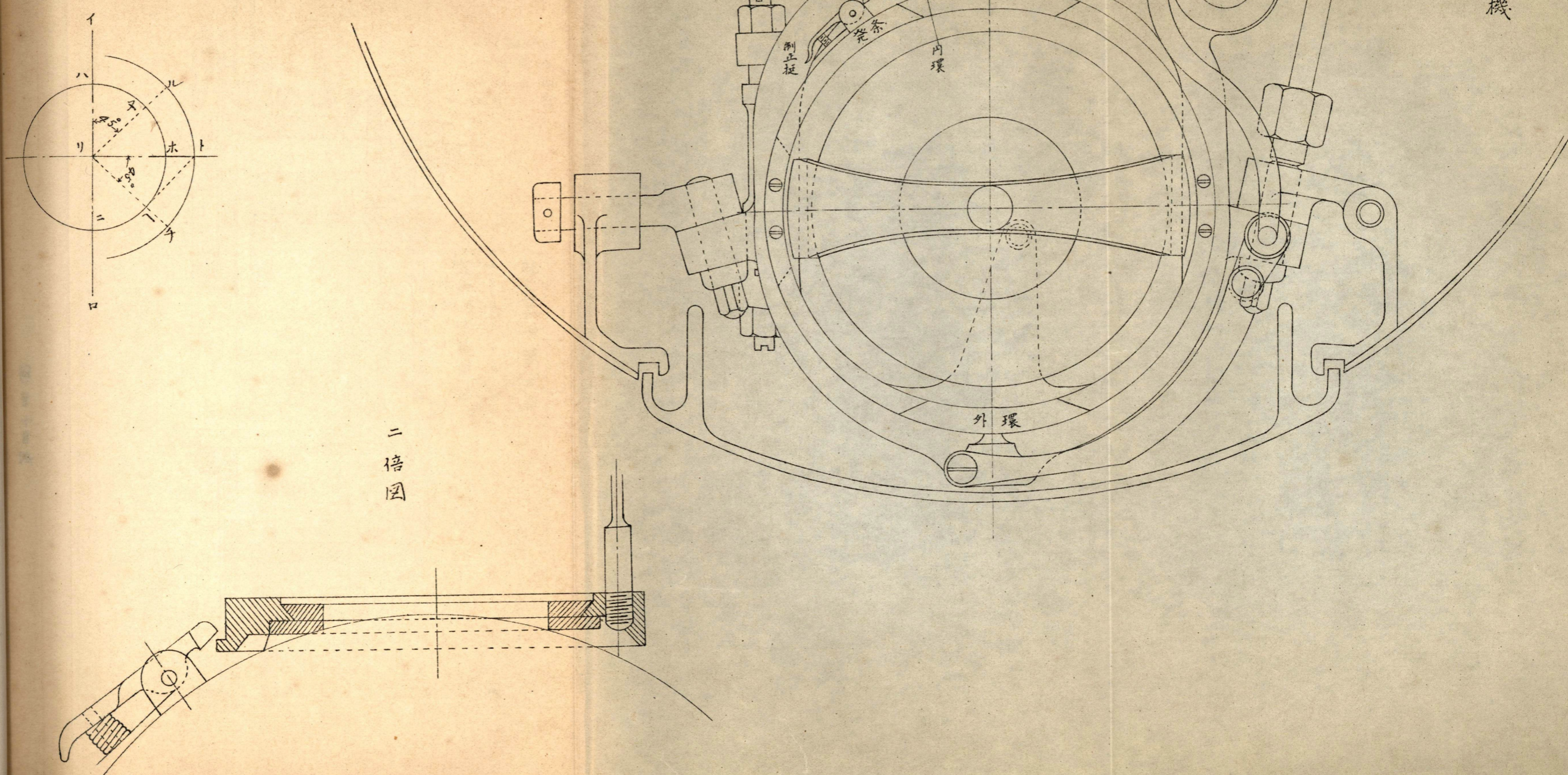

二倍図

四第 11



第四十四圖

三八式縱舵機前裝置

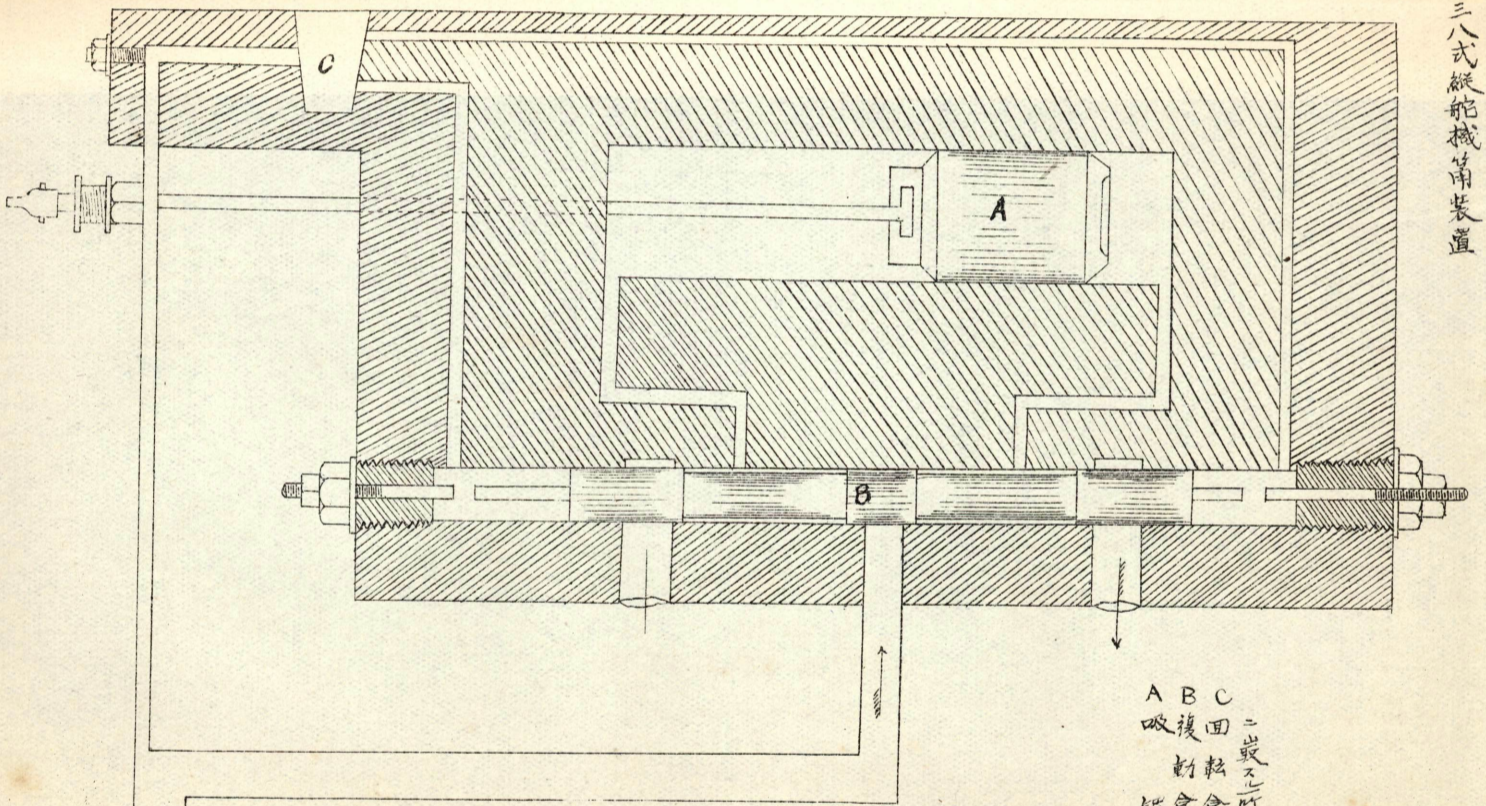

A B C  
 二吸後回  
 鈔餘餘  
 鈔餘餘  
 鈔餘餘

縱舵機用調和器

イ 口 ハ ニ ホ ト  
 余 余 厘 毫 突 調 基  
 框 杆 鈔 條 板 螺 板

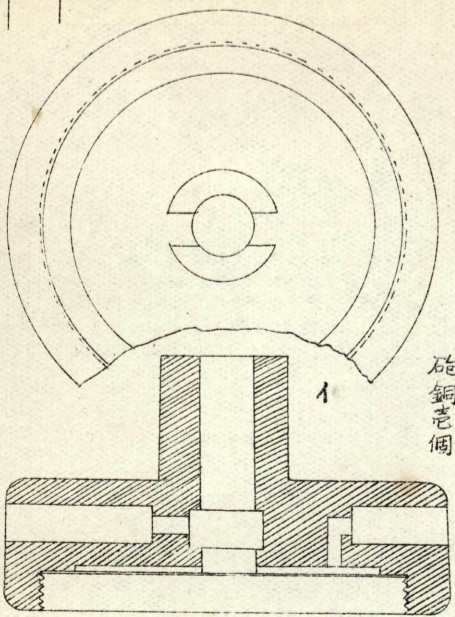

銅老個

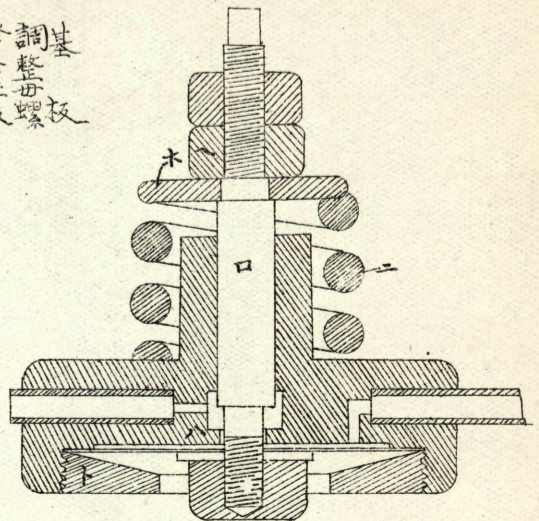

縦軸式  
 吹動機  
 吹口  
 V B C

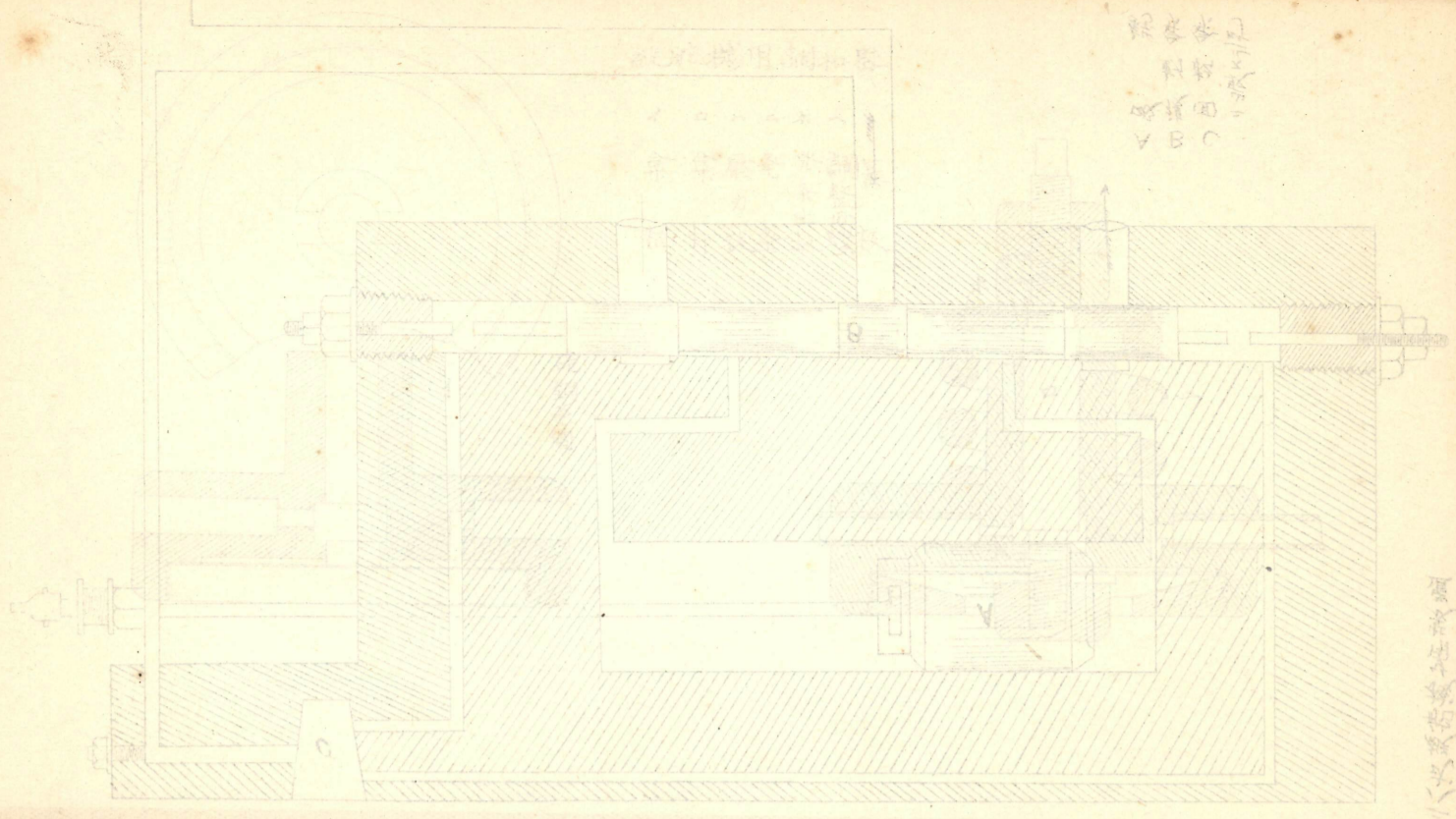

四〇式縦軸機

第四十五図

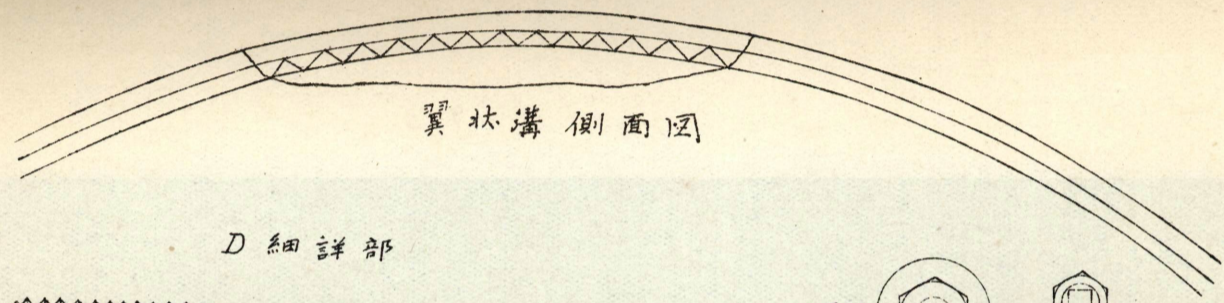

翼状溝側面図

D 細詳部

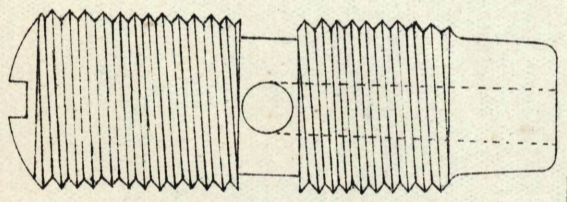

エルジックブロンズ

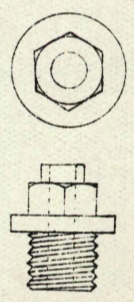

エスケープバルブ

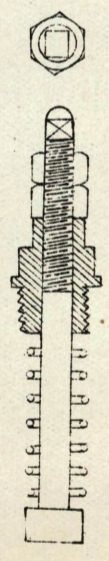

四〇式縦軸機

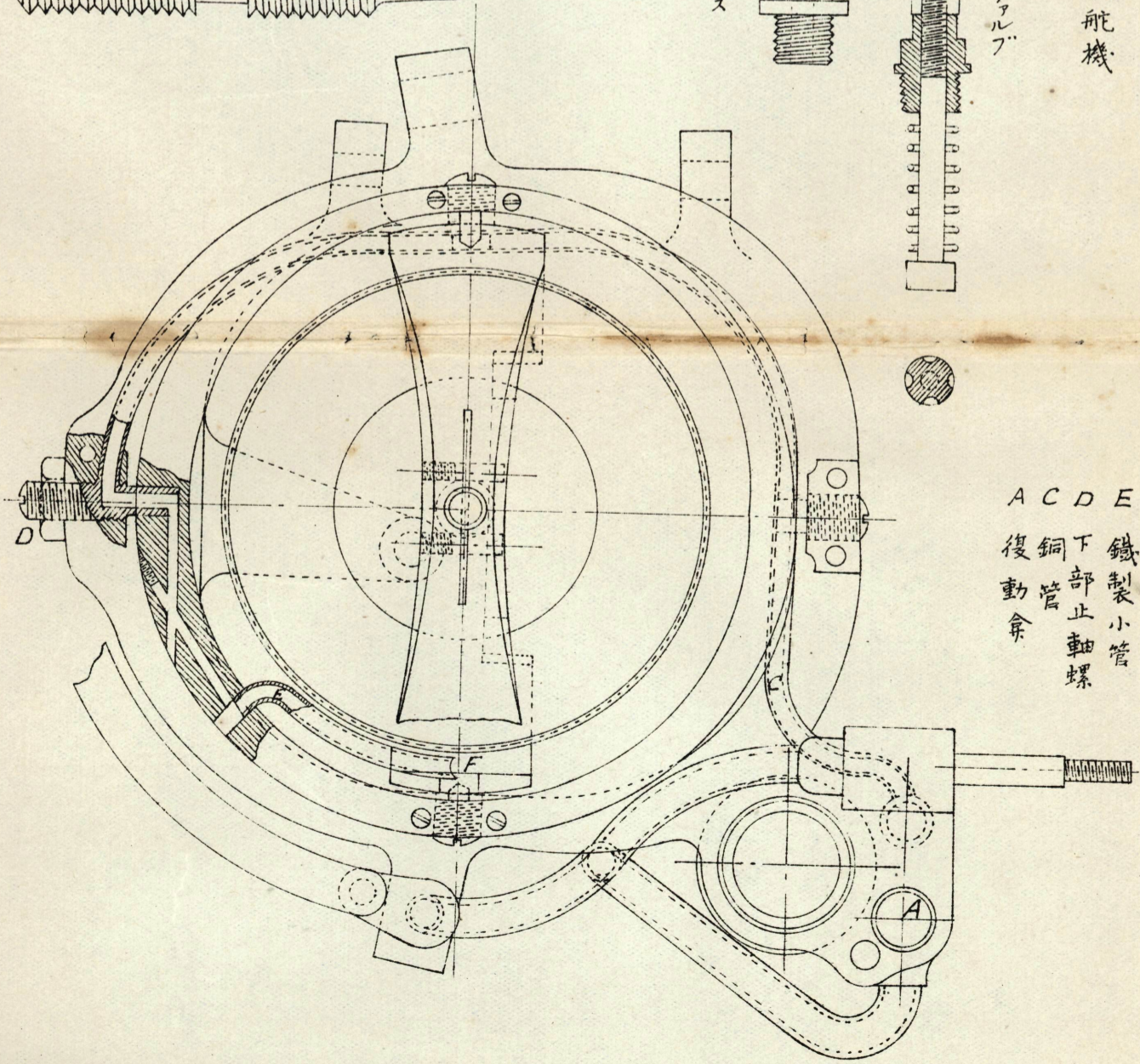

A C D E F  
 復動管 銅管 下部止軸螺 鐵製小管 吹氣口



圖 五 十五 號

四〇式(山口式)縱航調整器切斷圖



翼狀溝平面圖

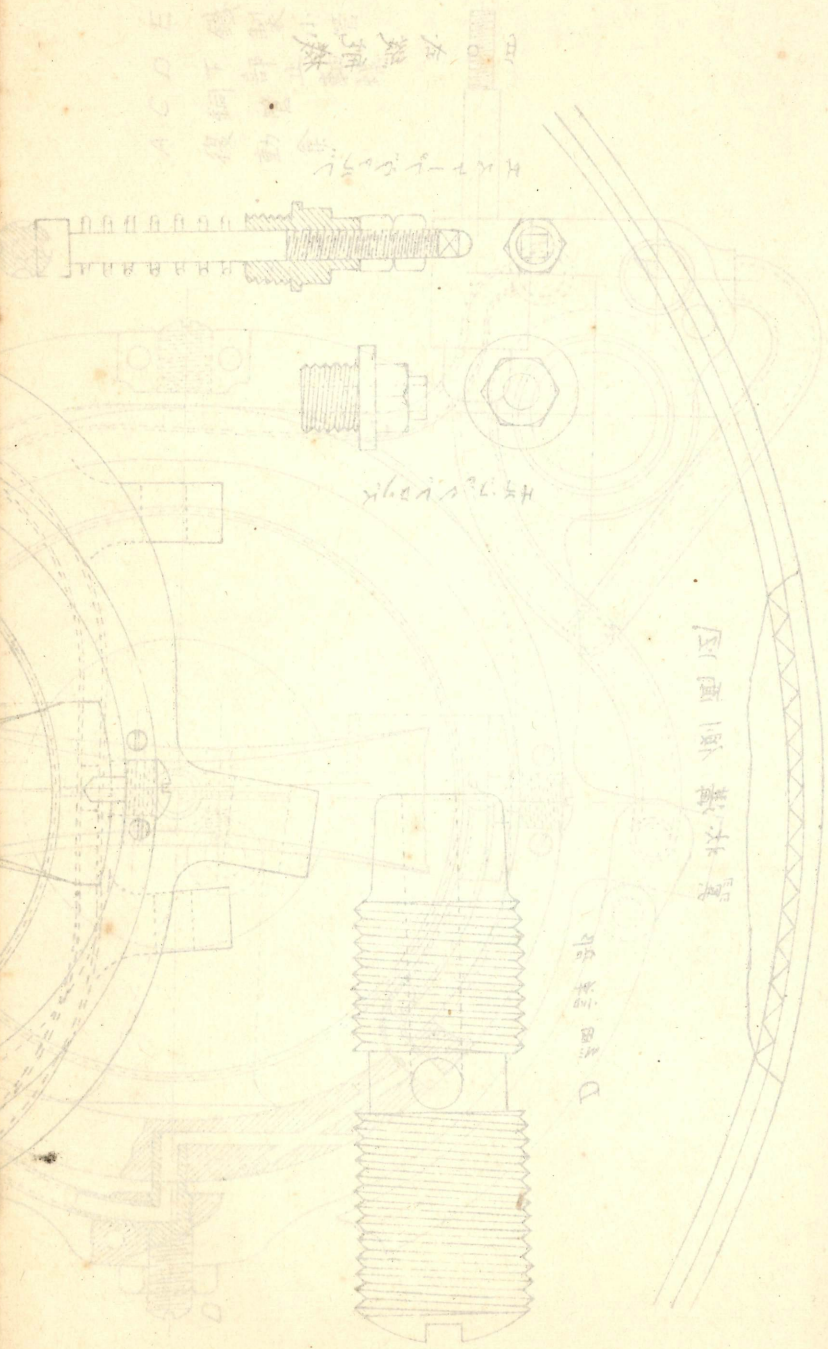
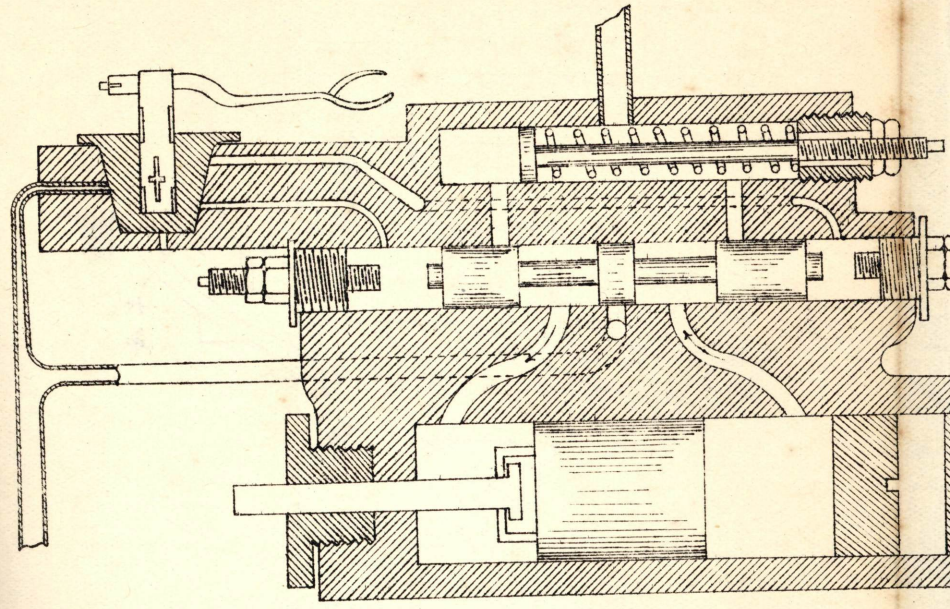
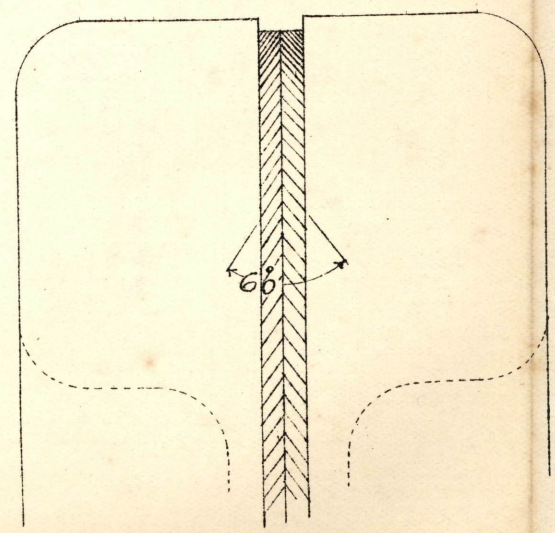

四〇式(山口式)縦航調整器切断図

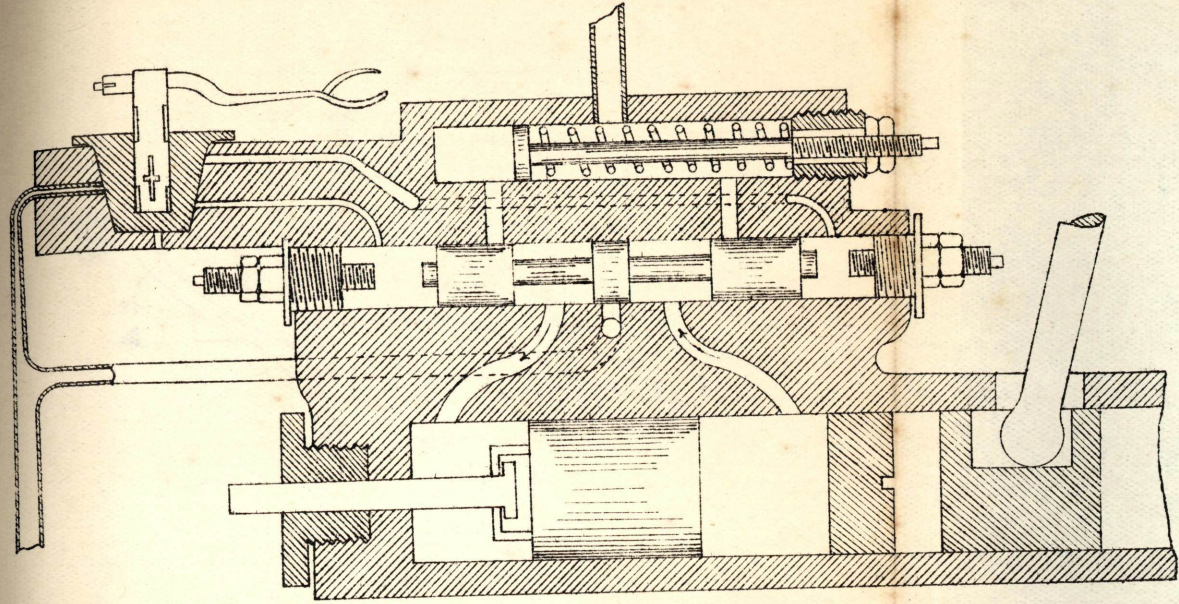

翼状溝平面図

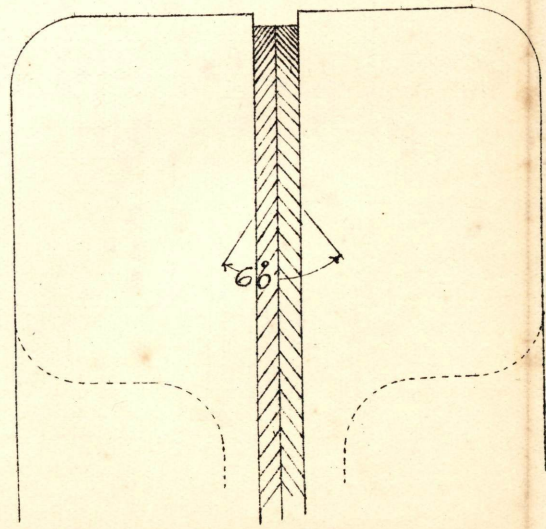

- G 翼状溝
- C 銅管
- B エスケープバルブ
- A ヴァルブスライド

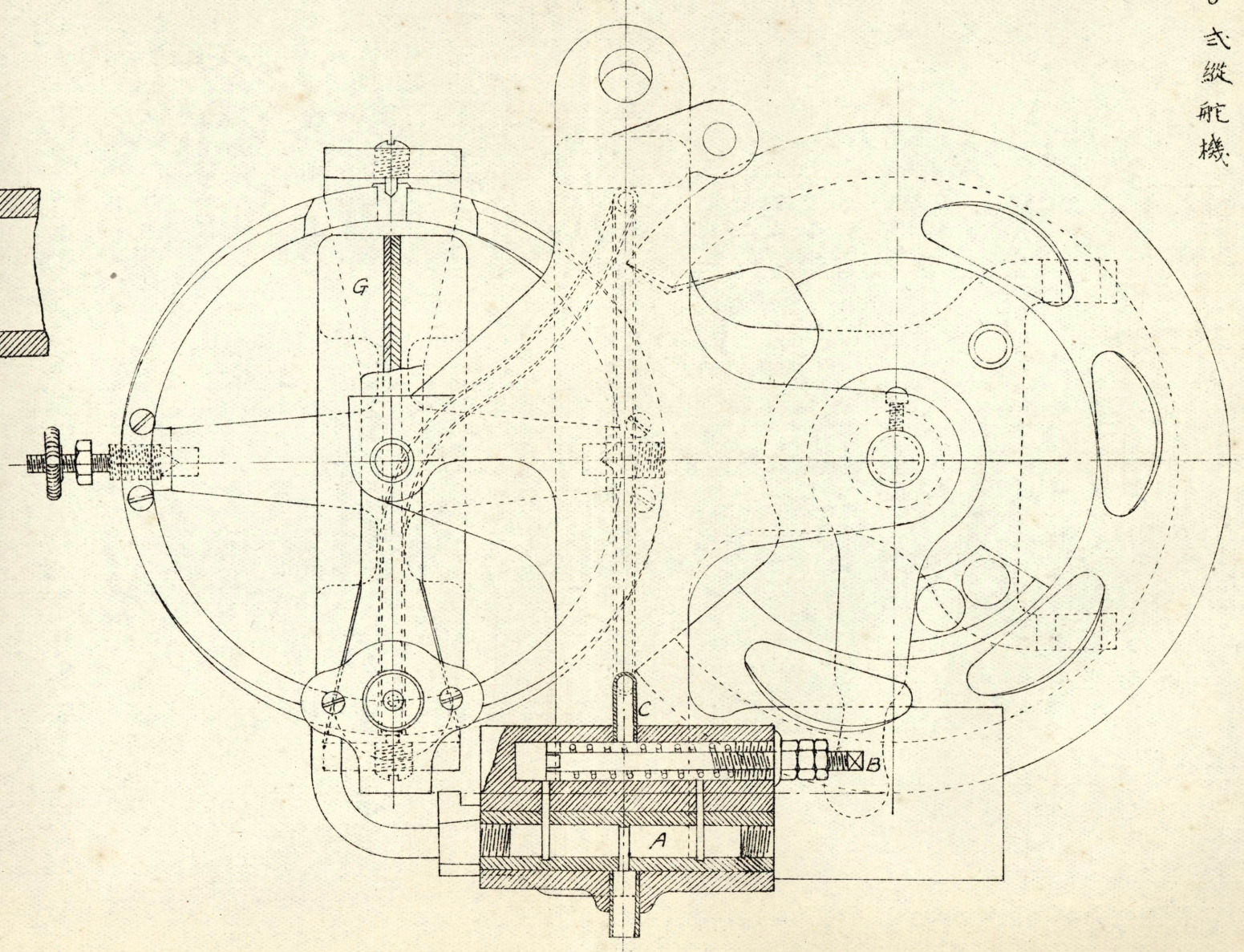

四〇式縦航機

第四十七圖

四三式總舵機

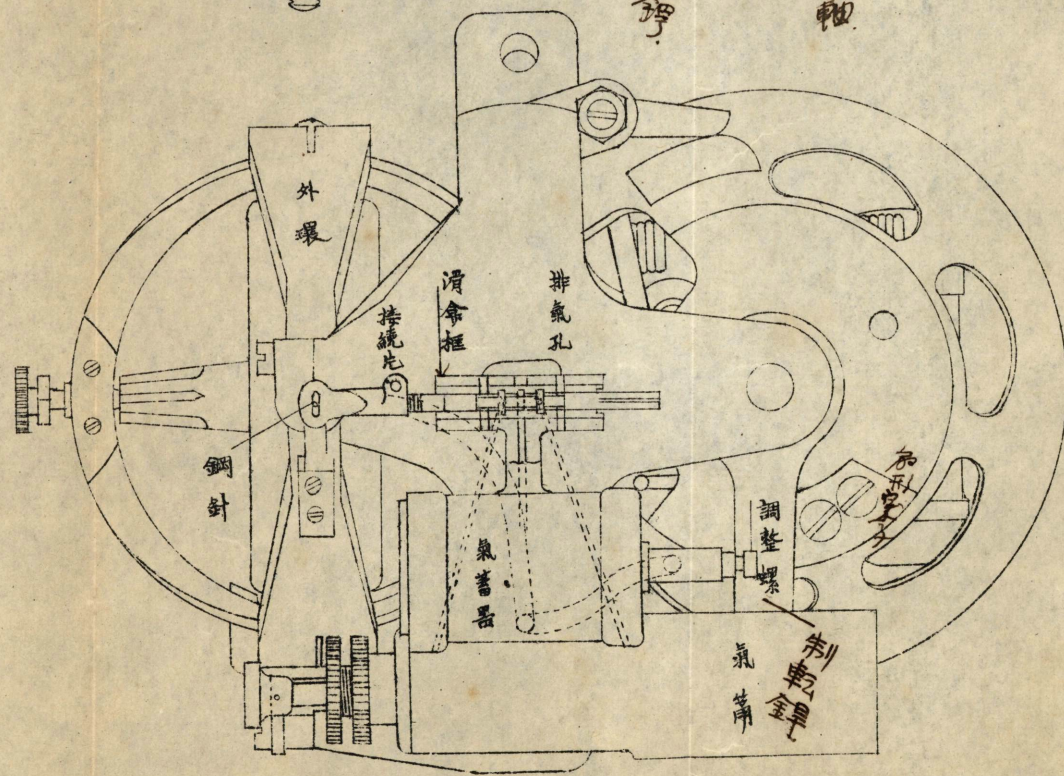
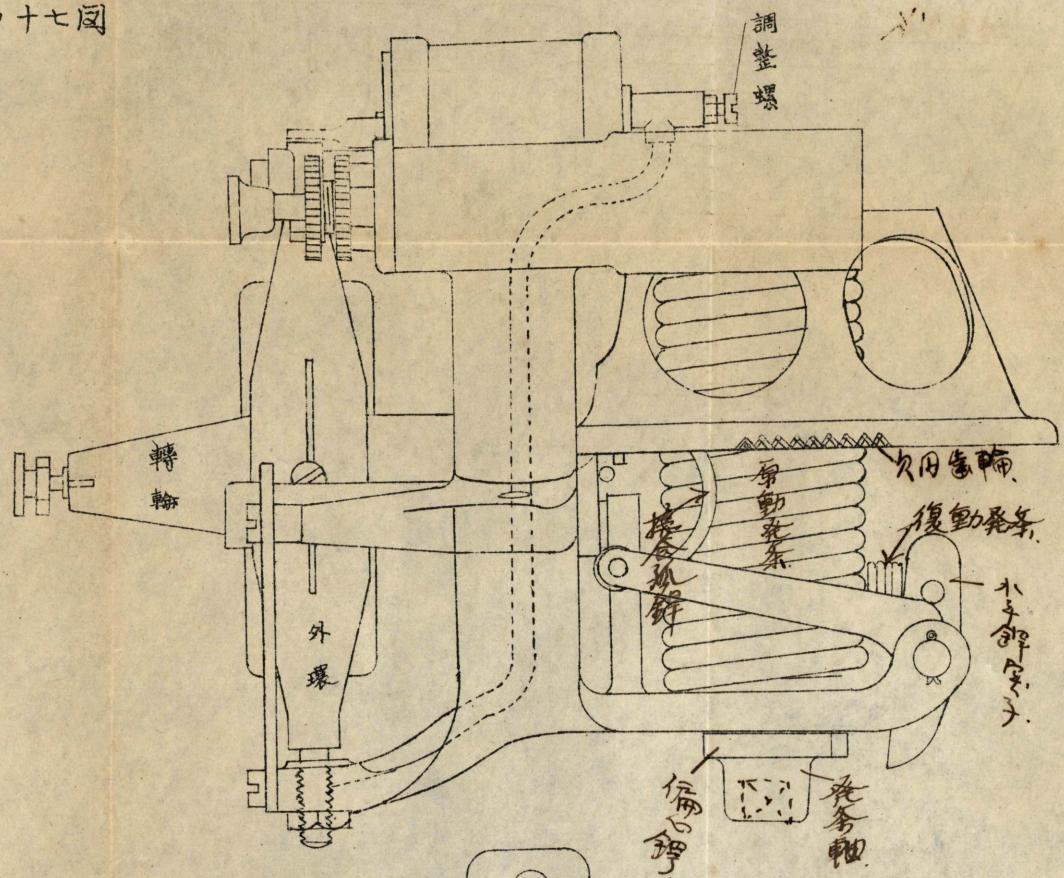
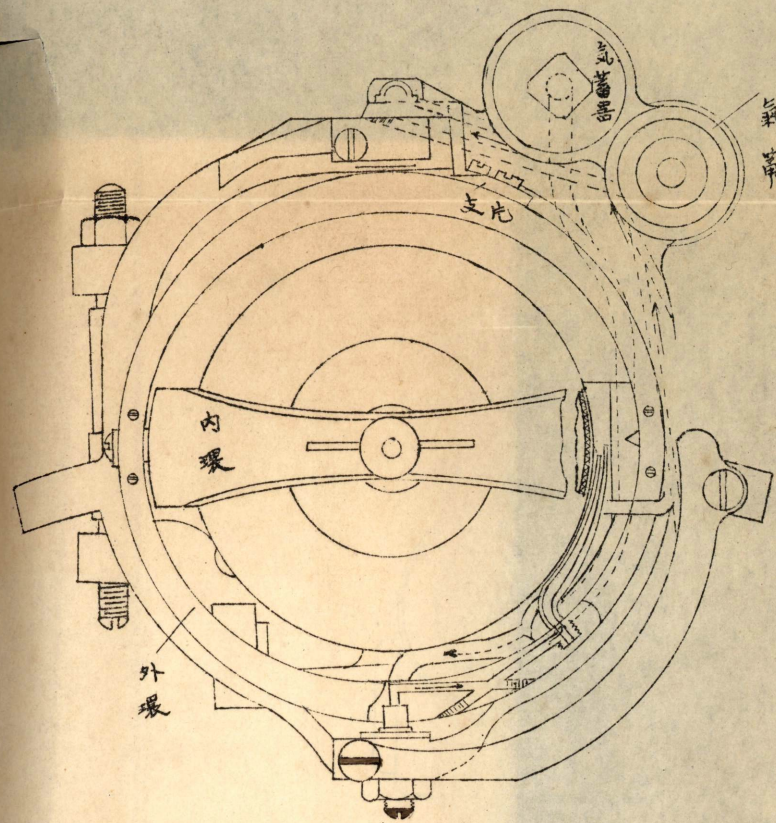

四三式總舵機 (左側) 剖面圖

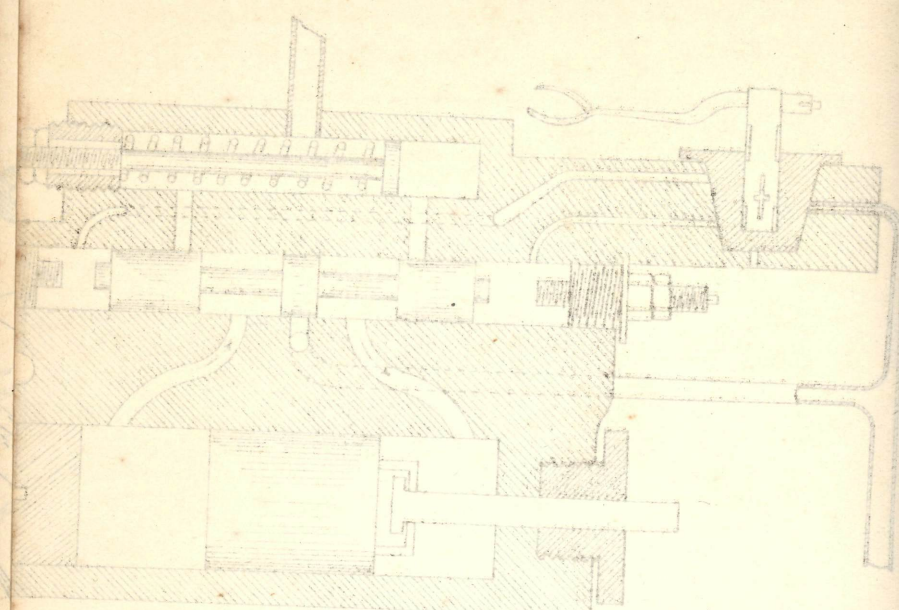

外環平面圖

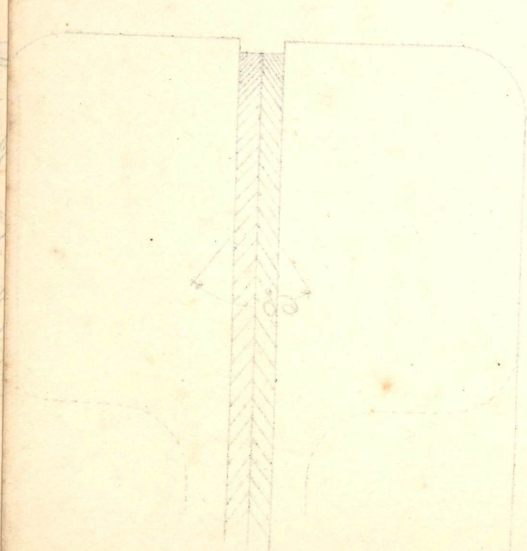



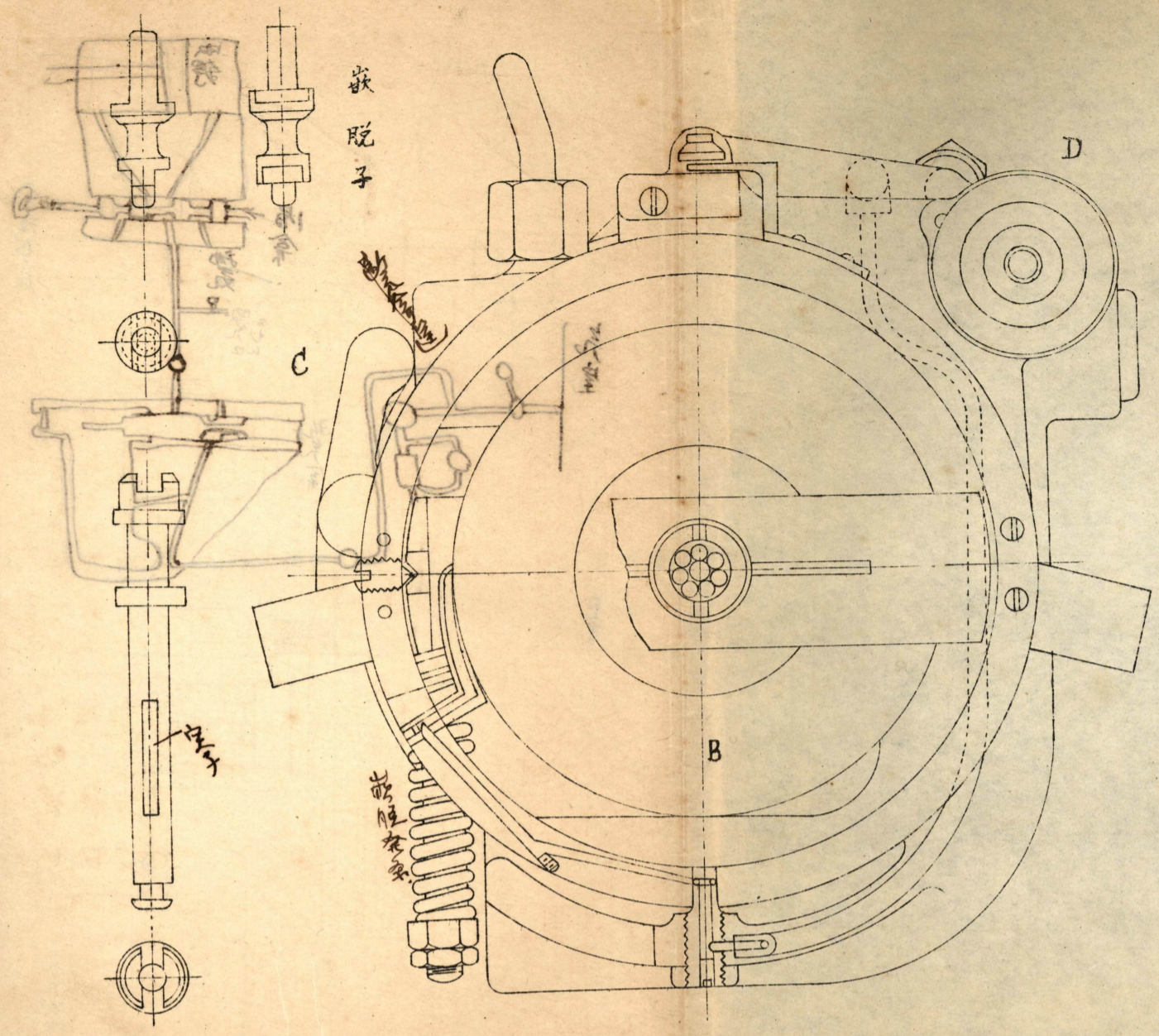

A B C D  
 旋轉氣  
 動脈  
 輪軸挺第

E G H M  
 氣嵌嵌調  
 蓄脫脫和  
 器器器器

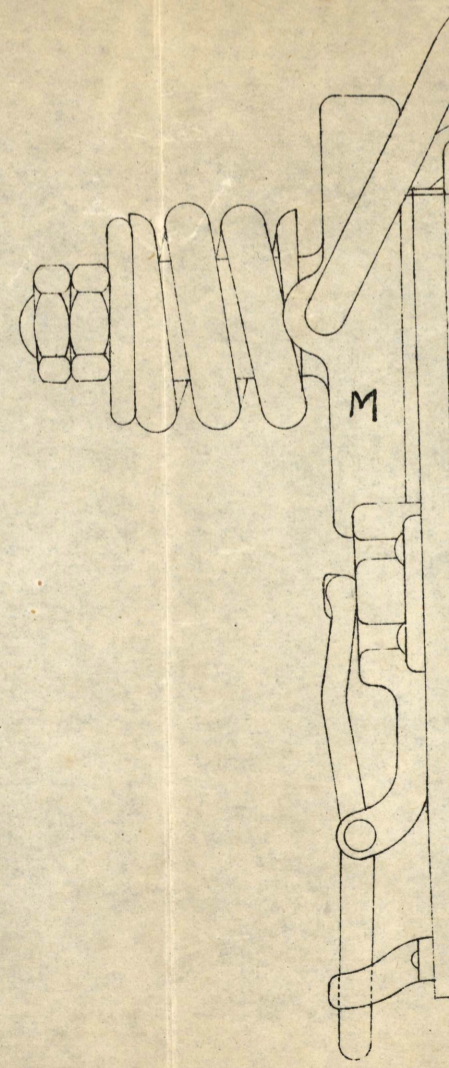
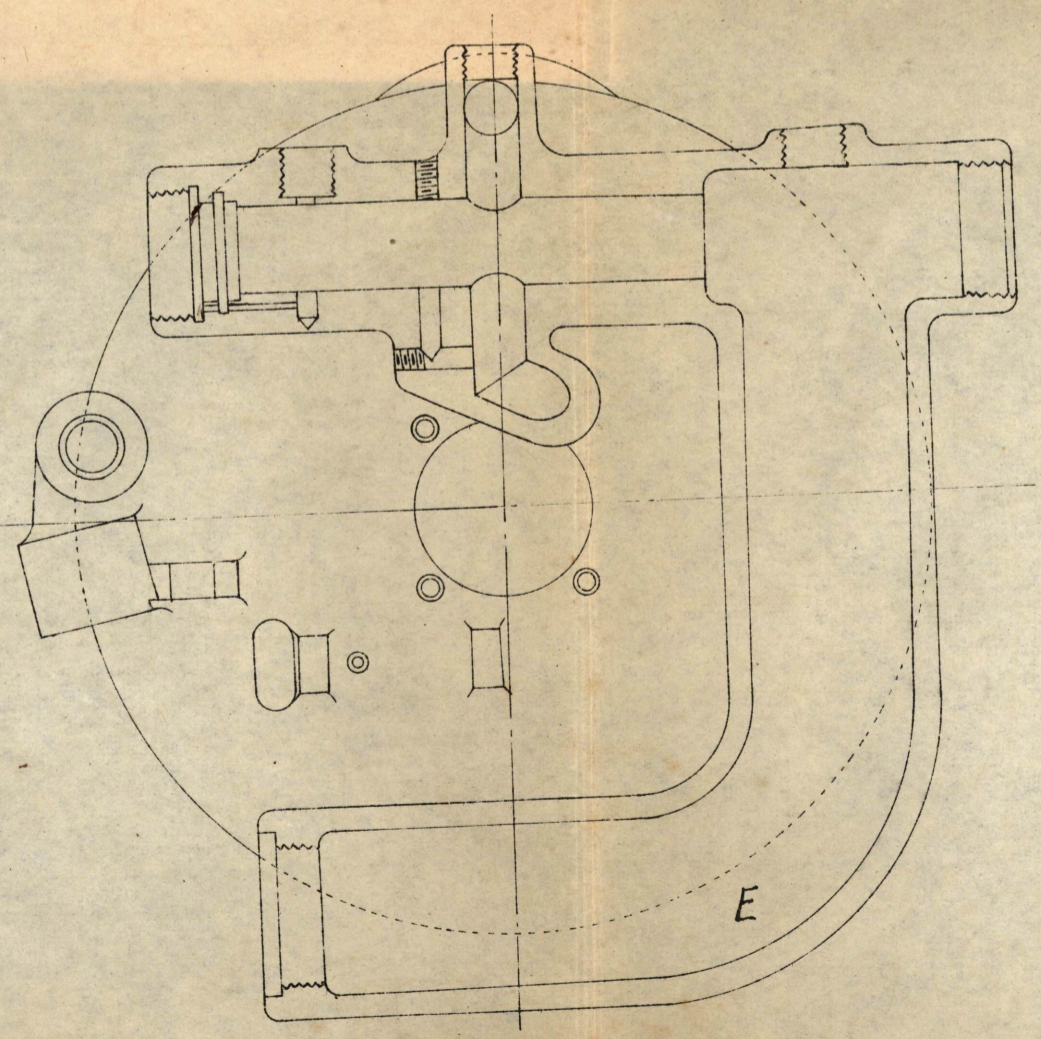



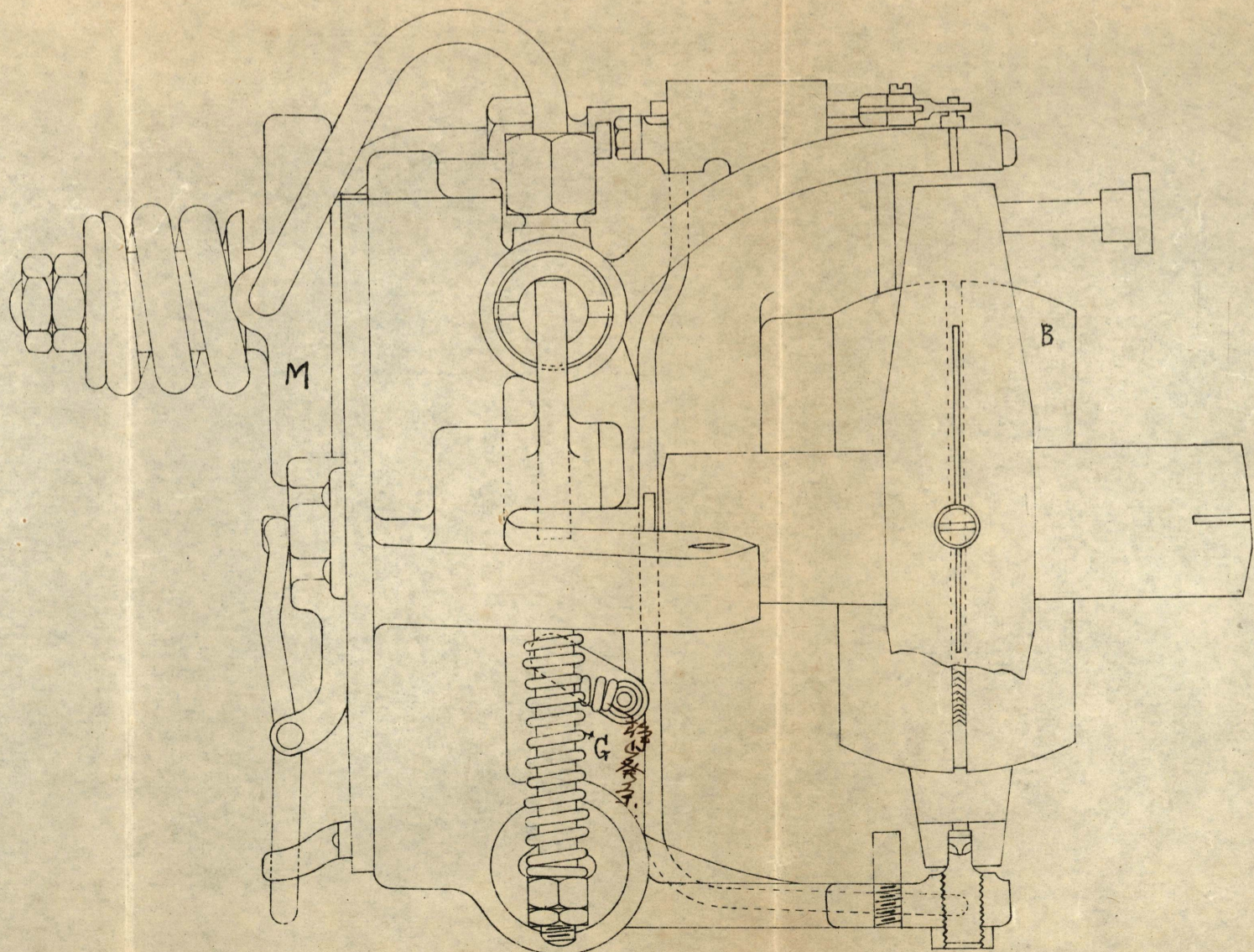
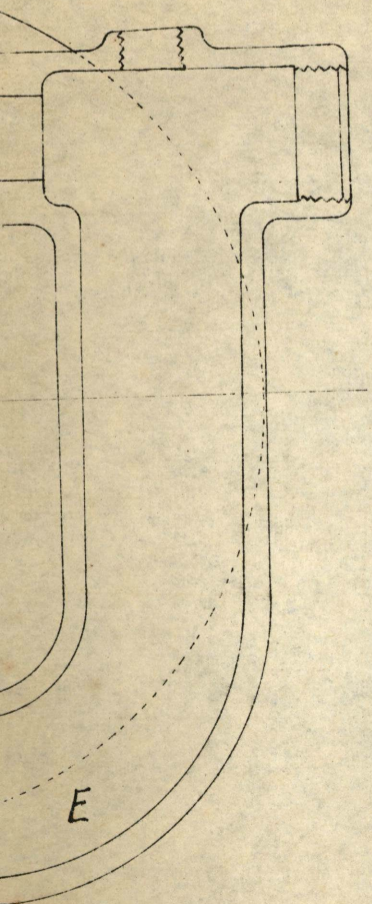
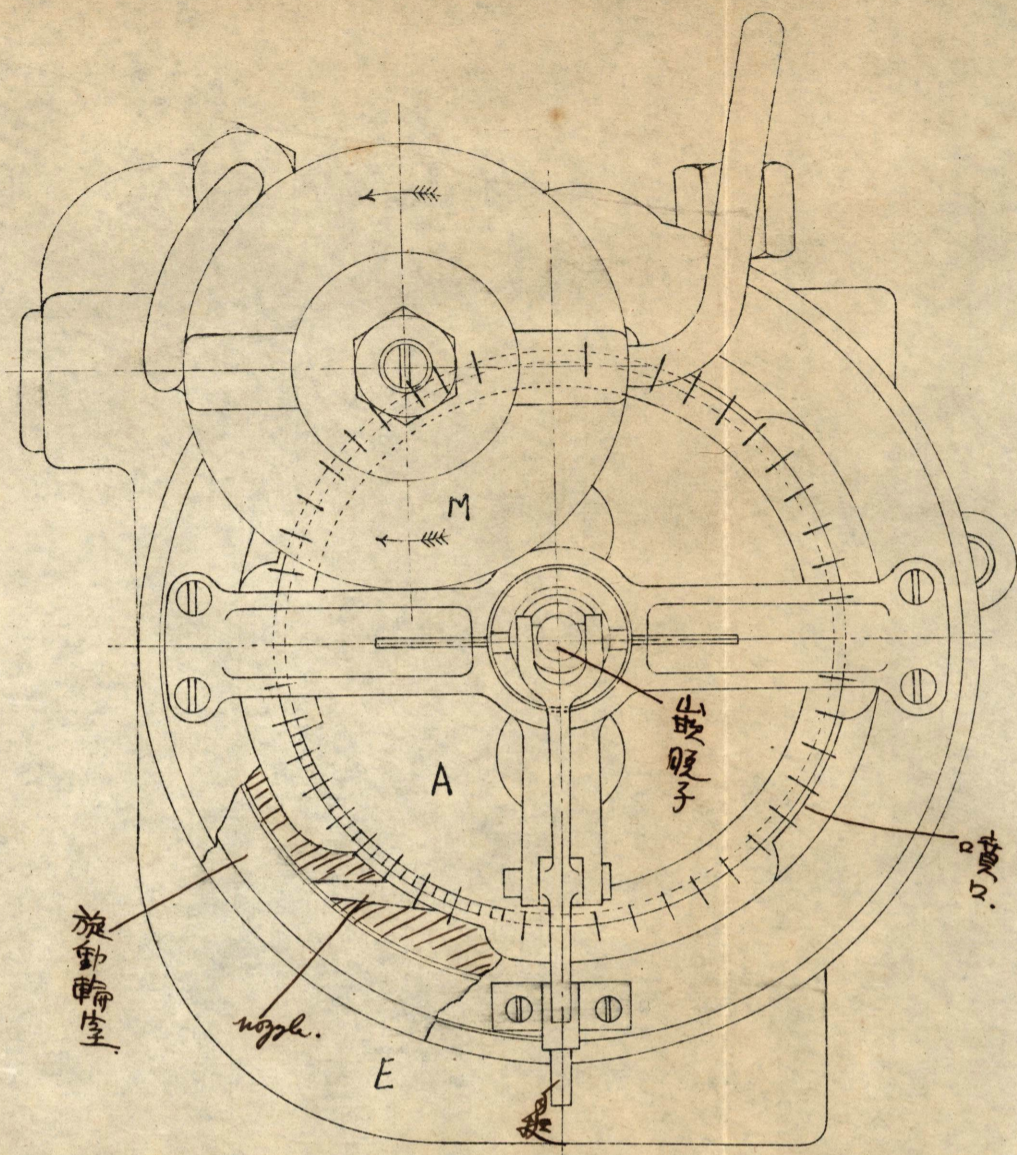
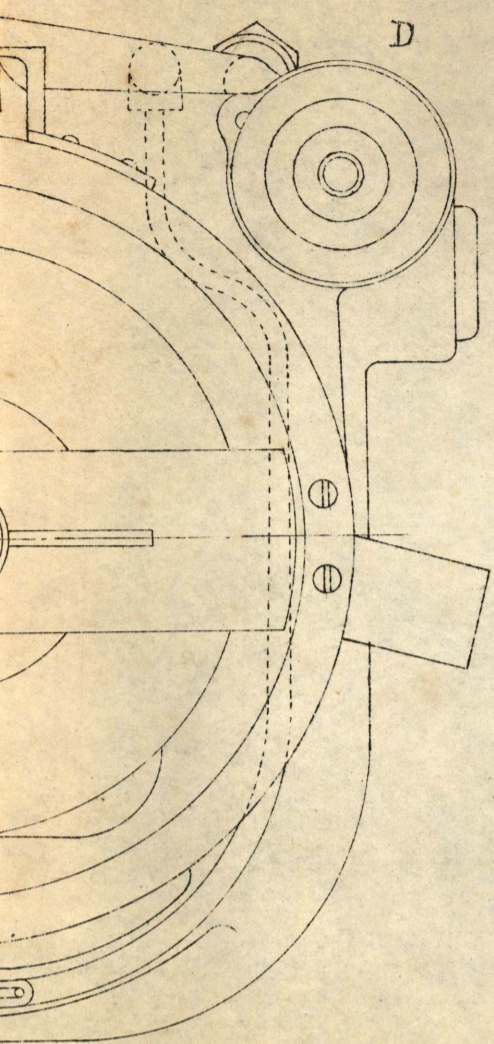

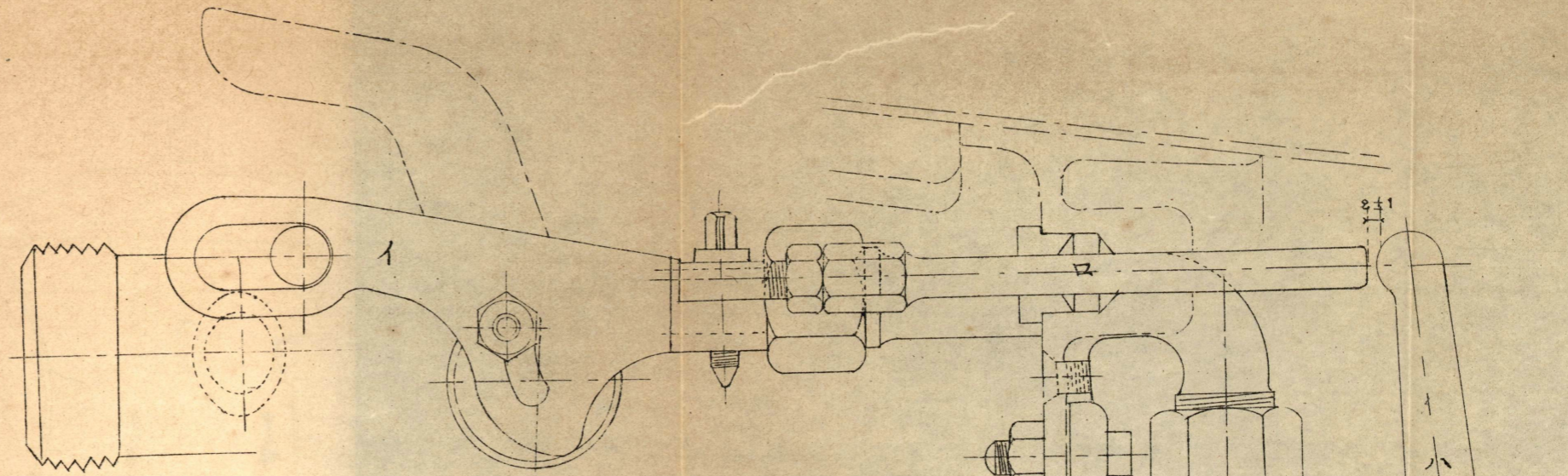

ホニハ口  
 余損推發  
 (至至)  
 錚錚錚錚

F 斷氣余  
 E 氣蓄器

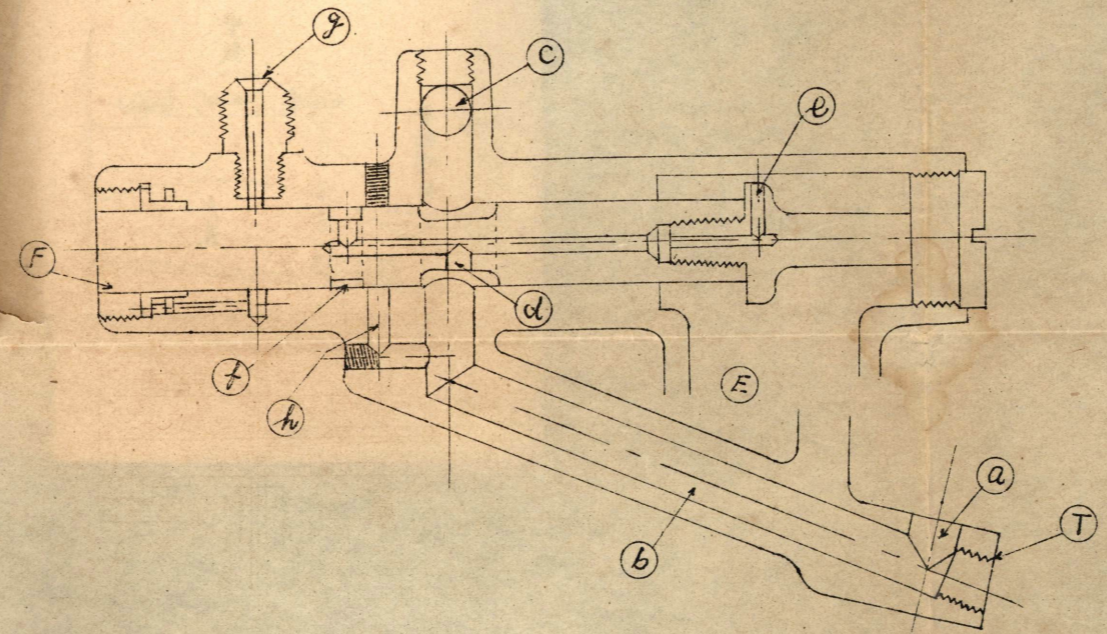

至能機

蓄氣器

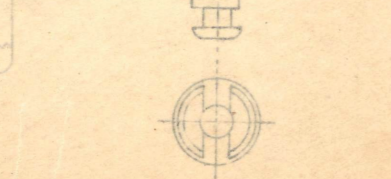
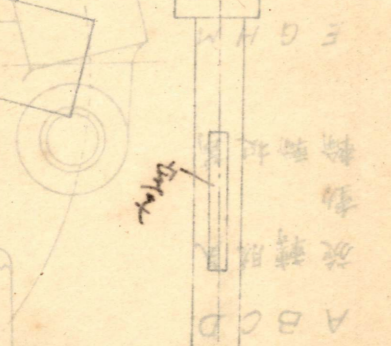
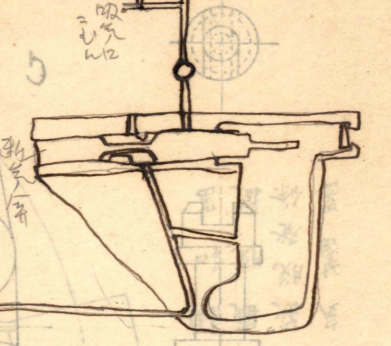
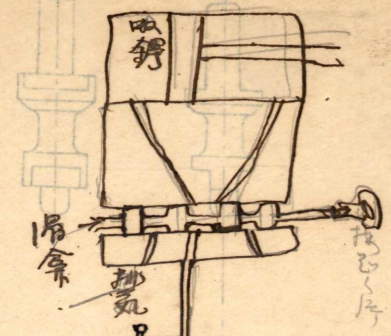

先室

新入部

新入部

換氣器

A B C D

縱舵機發動裝置及支名

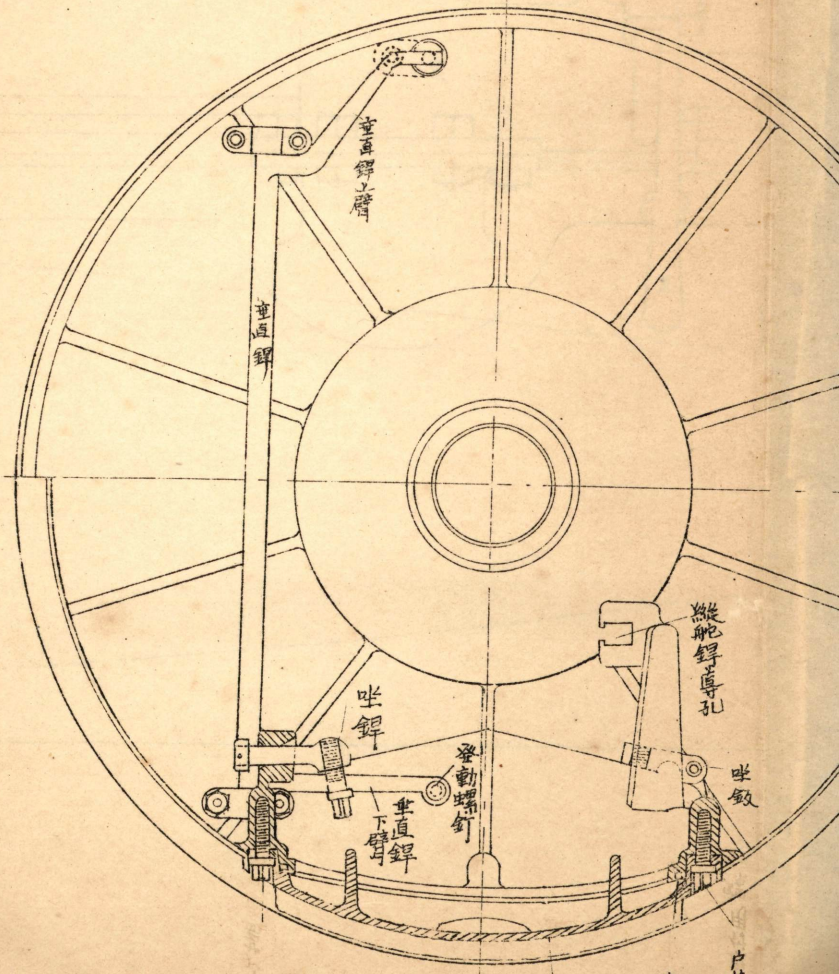

戶蓋取付用螺釘

戶蓋

衛帶

戶蓋取付用螺釘

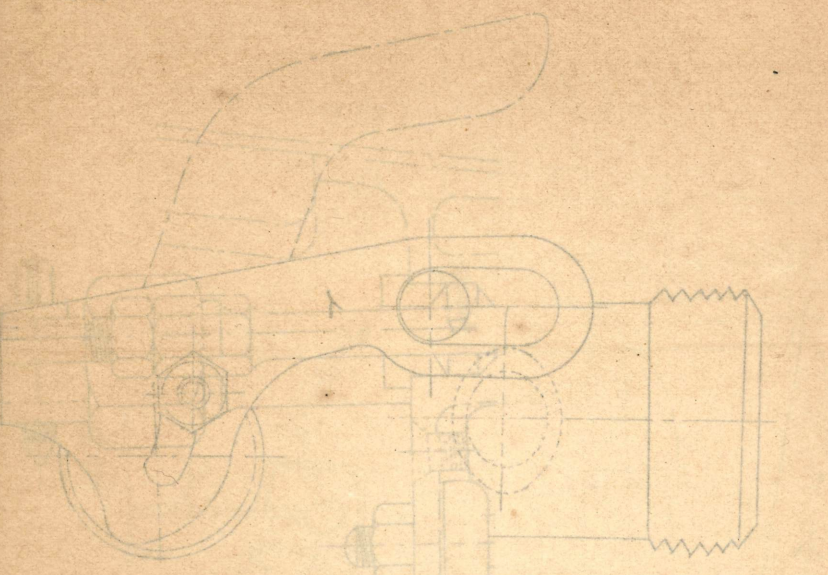

三葉蓄器  
福原系

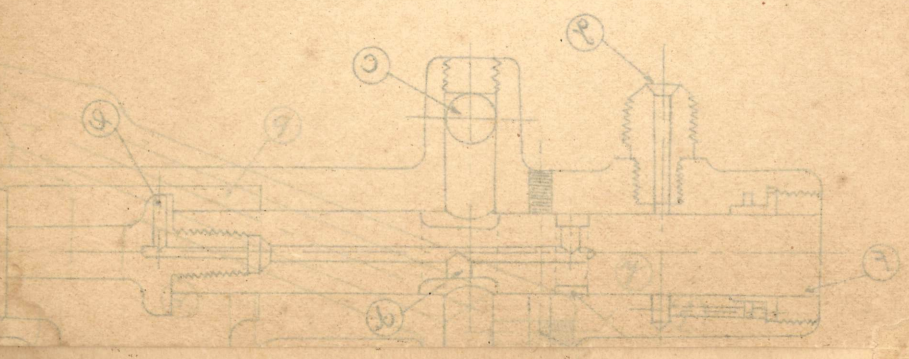

縱舵機發動裝置及支名

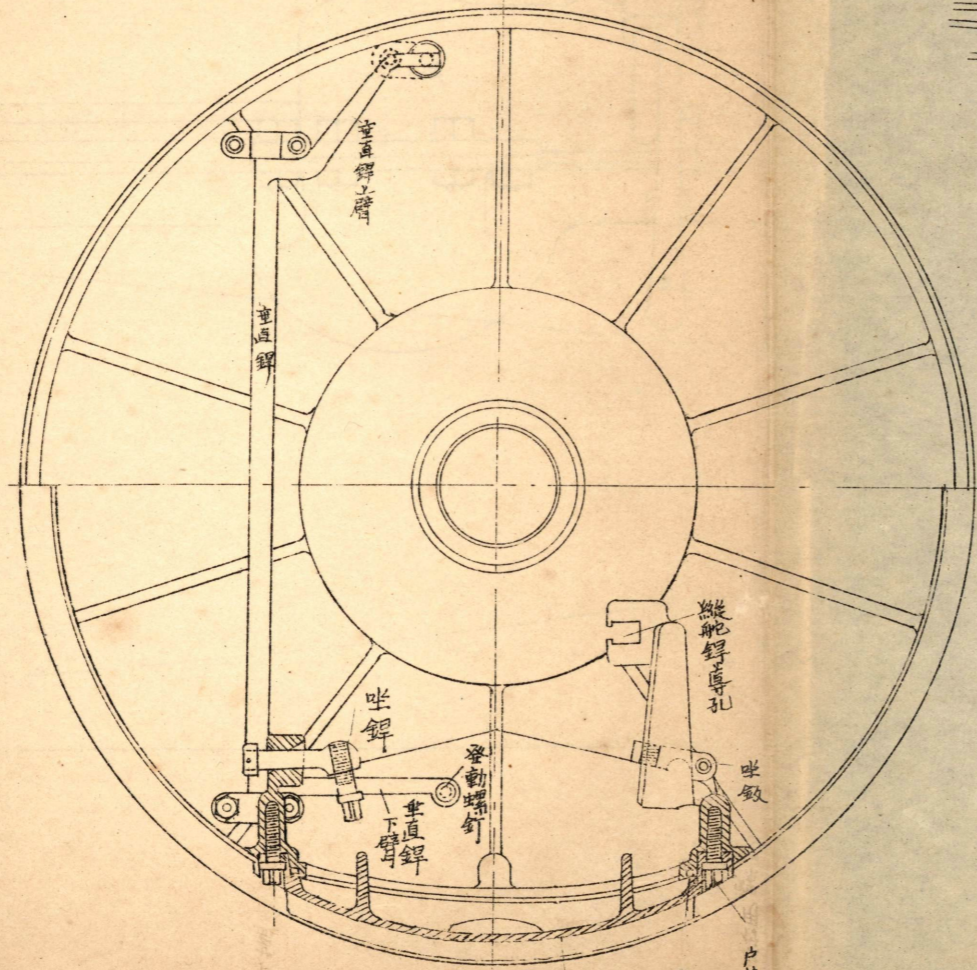

戶蓋取付用螺釘  
 戶蓋  
 衛帶  
 戶蓋取付用螺釘

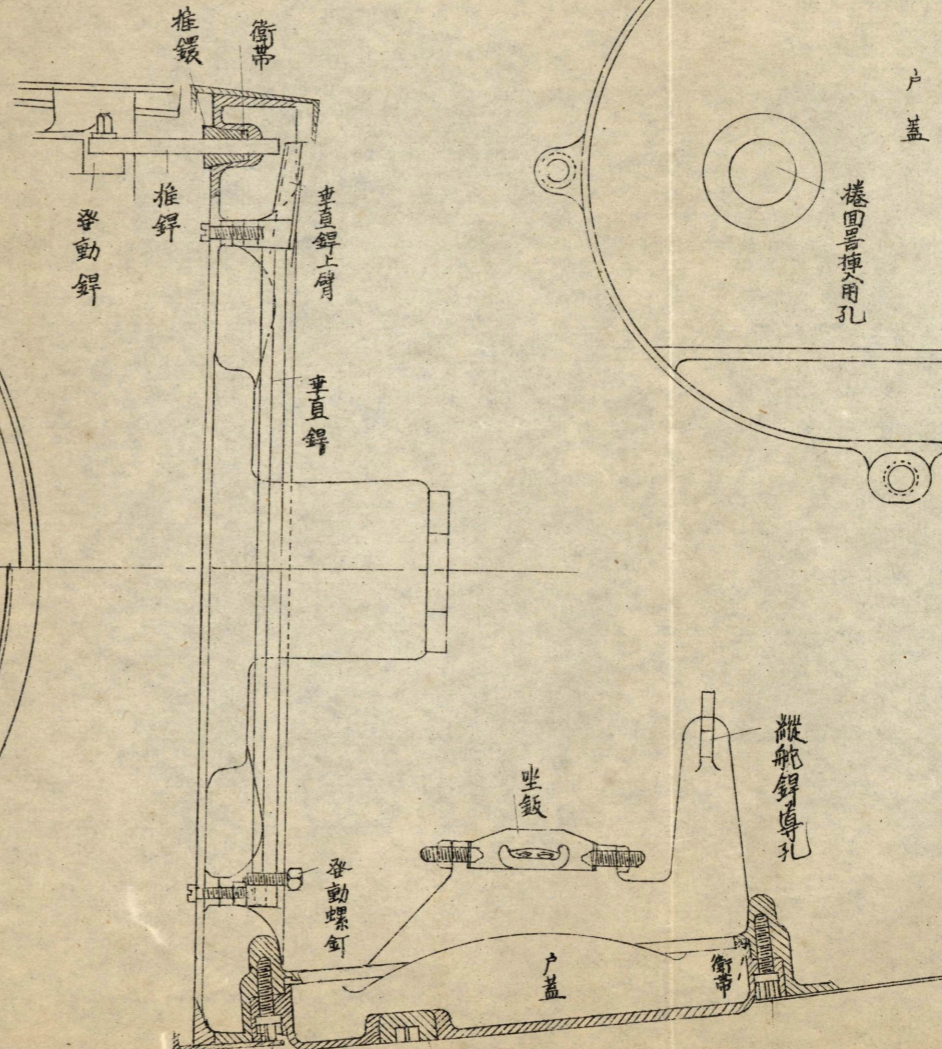

戶蓋取付用螺釘  
 捲回器插入用孔  
 戶蓋  
 戶蓋取付用螺釘

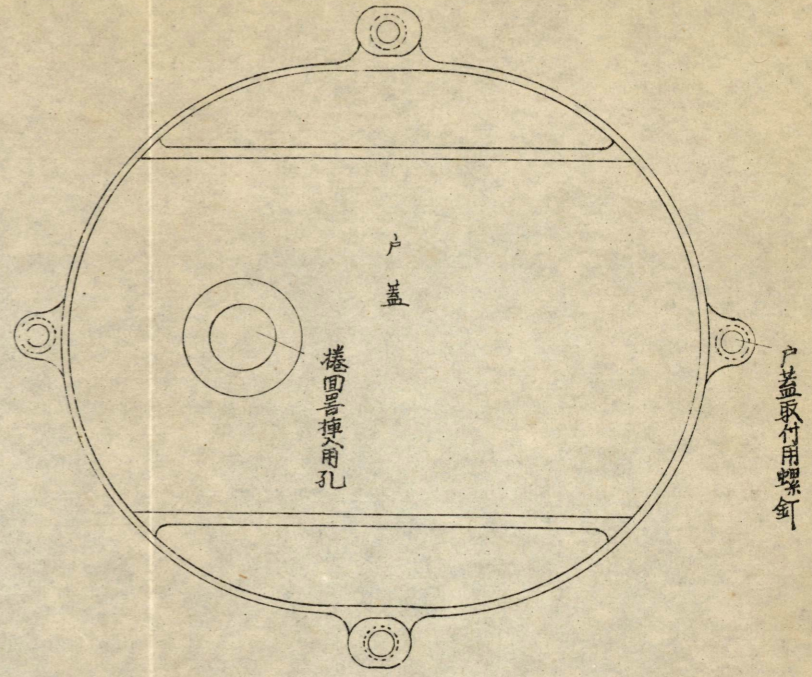

戶蓋取付用螺釘

機軸各機件置及支台

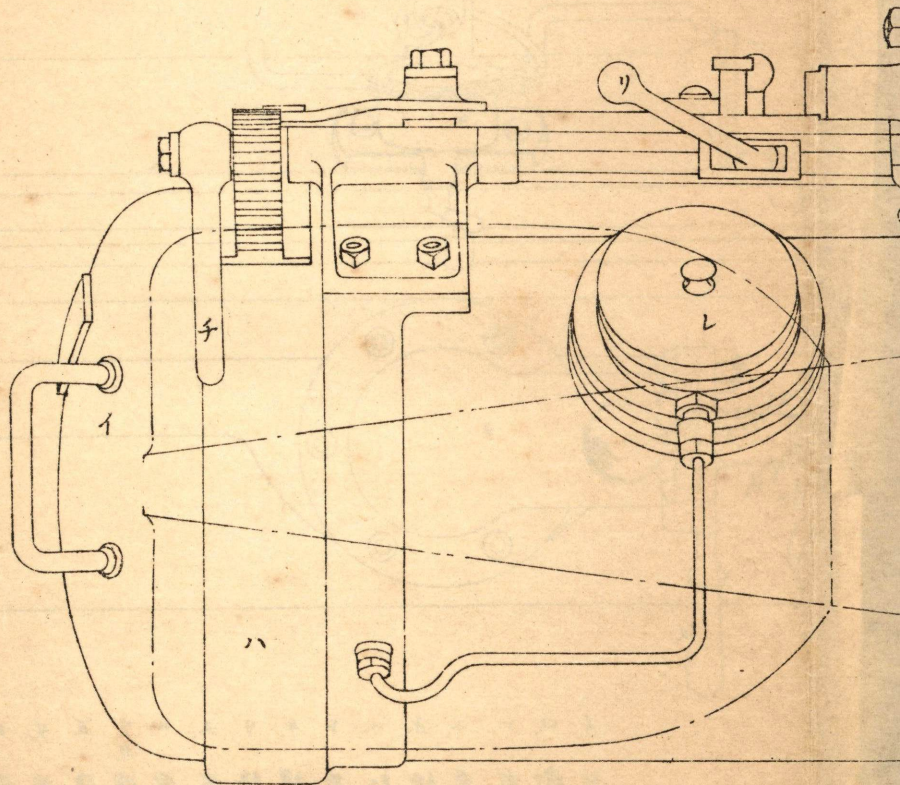
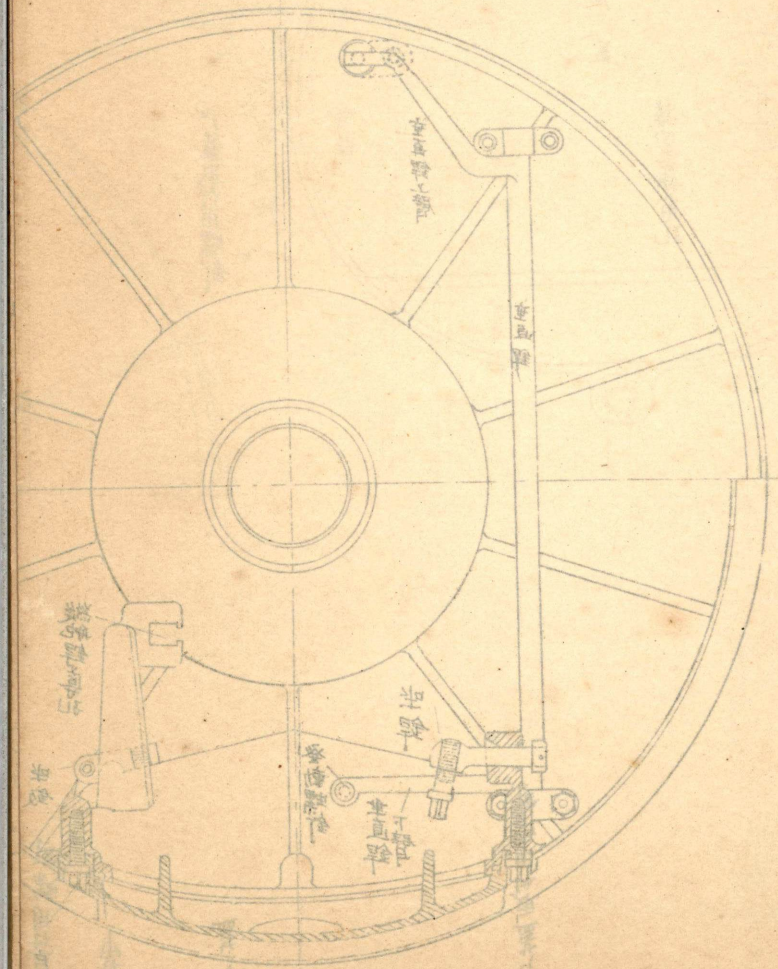

第五十圖

保式匙狀回旋發射管側面圖

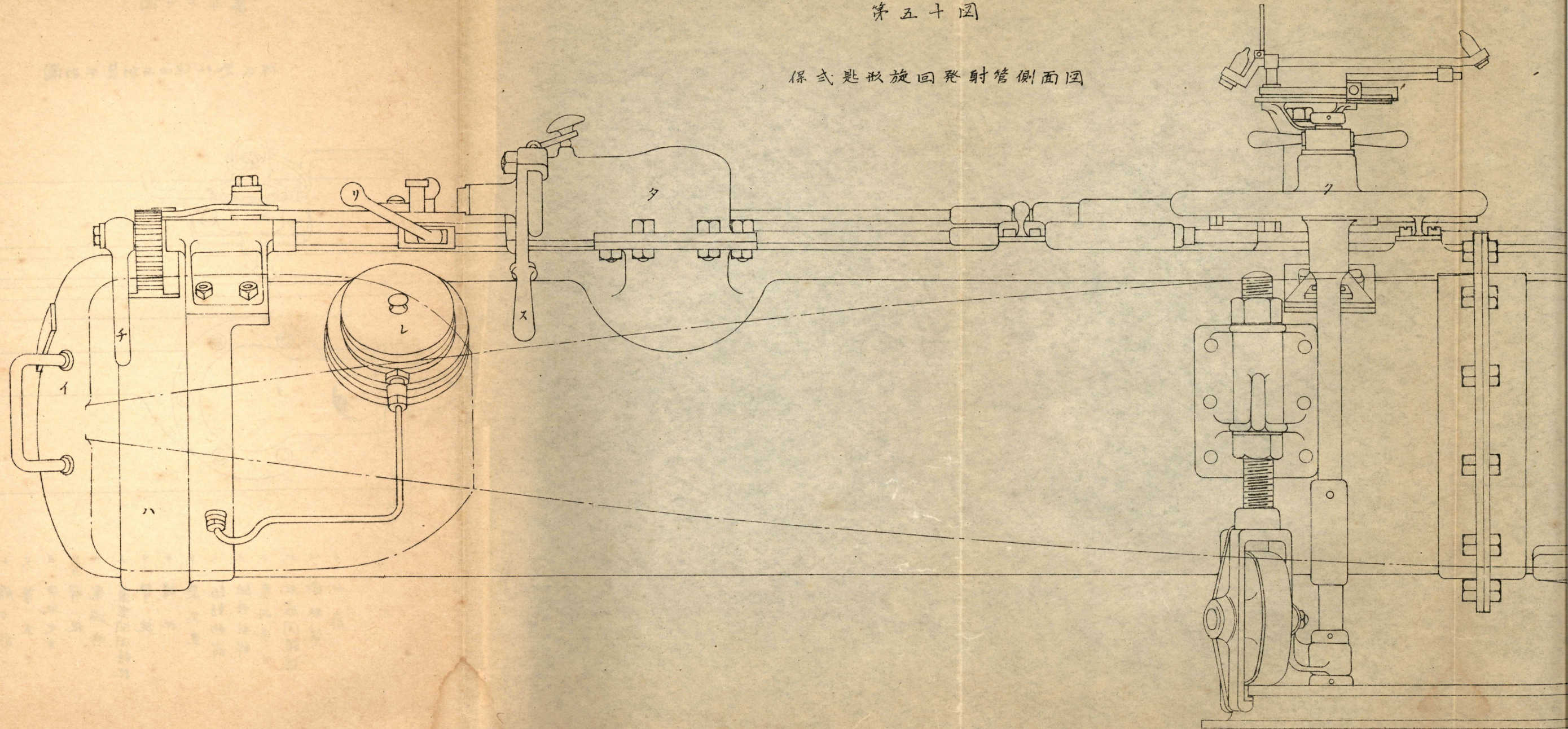

機軸在機架置及支台

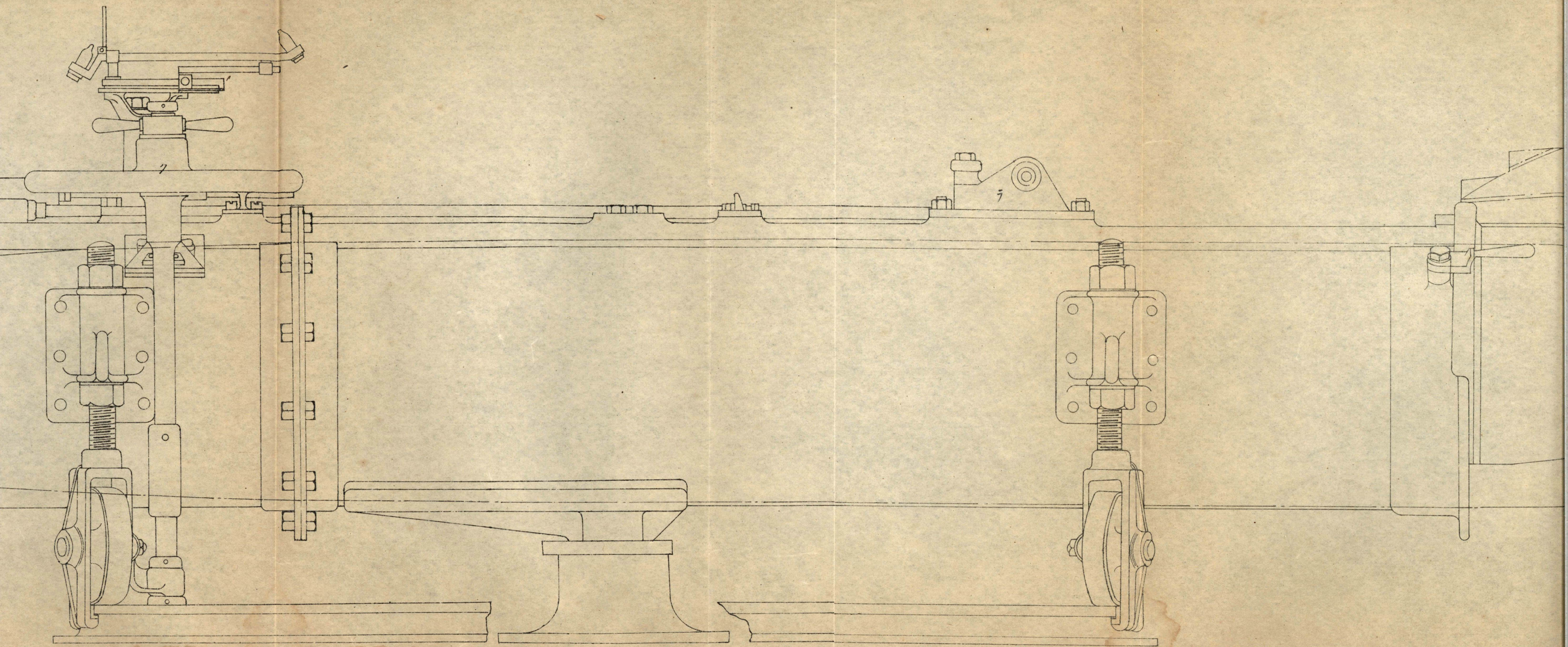



→前部



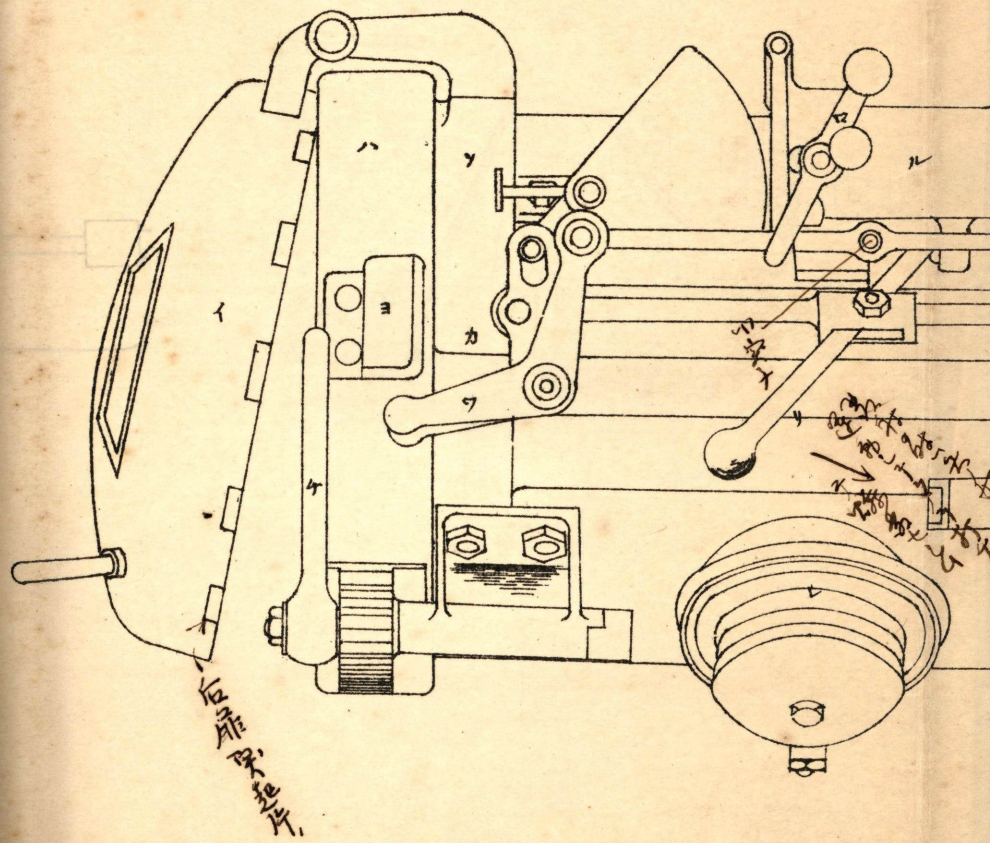
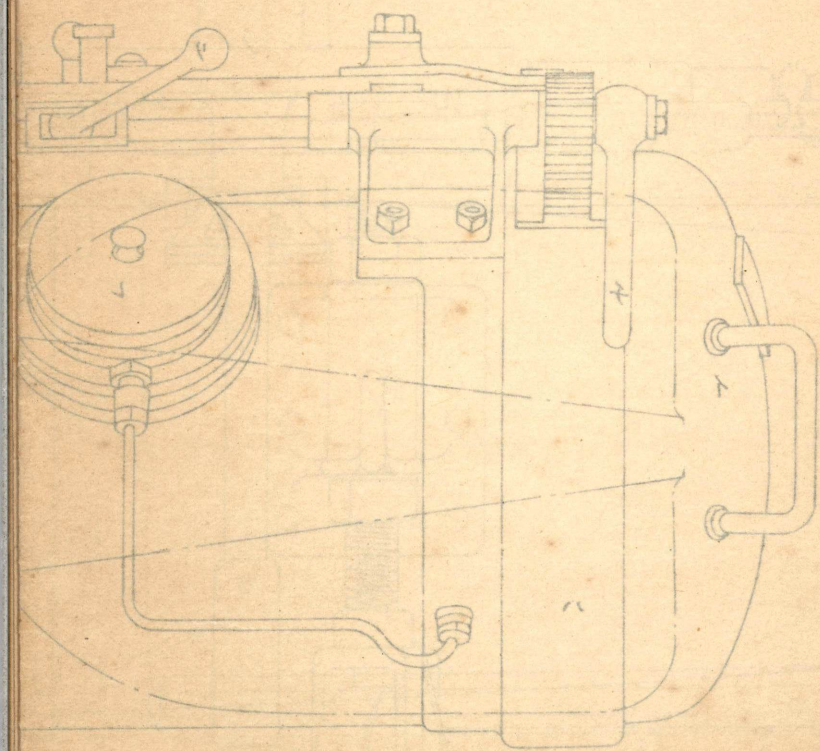

第五十一圖

保式足形旋回射管平面圖

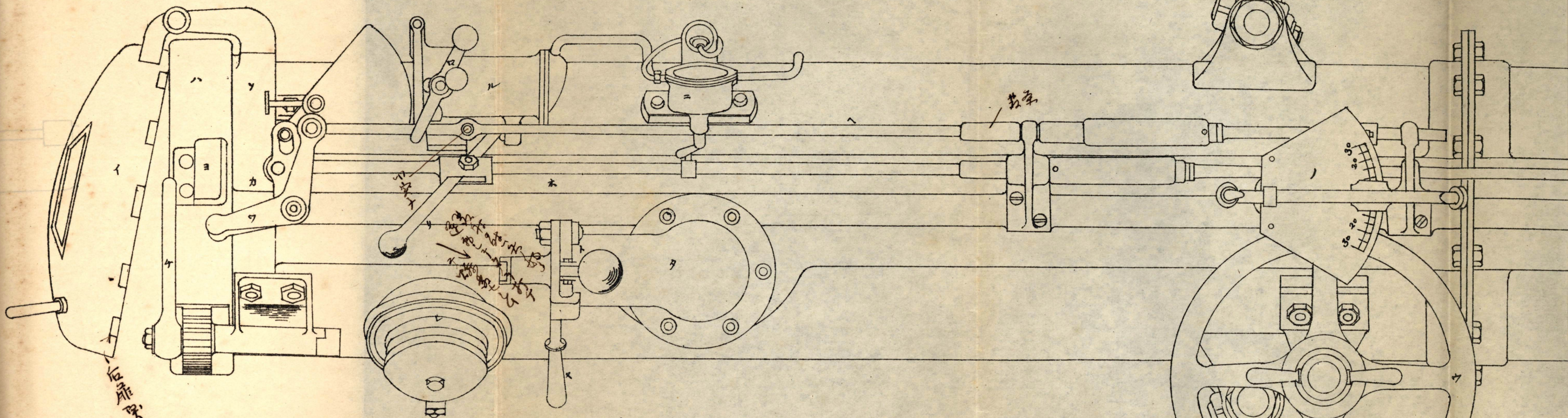
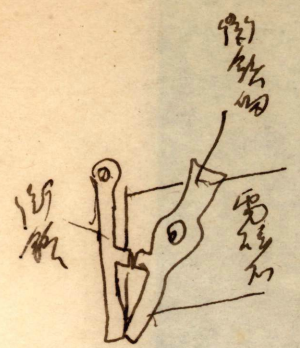

- イ 右扉
- ロ 右扉閉鎖
- ハ 右扉閉鎖
- ニ 變向器
- ホ 維持針錐
- ヘ 起動針錐
- ト 藥室
- チ 擊把
- リ 藥室閉鎖轉把
- ヌ 藥室閉鎖轉把
- ル 電磁
- レ 臂受金
- ヲ 藥室
- リ 壓力計
- ソ 衝鉄押
- ツ 電氣觸着
- テ 環狀管座
- チ 起形
- ヲ 維持針
- ム 起動鉤
- ウ 旋回機
- カ 方位盤

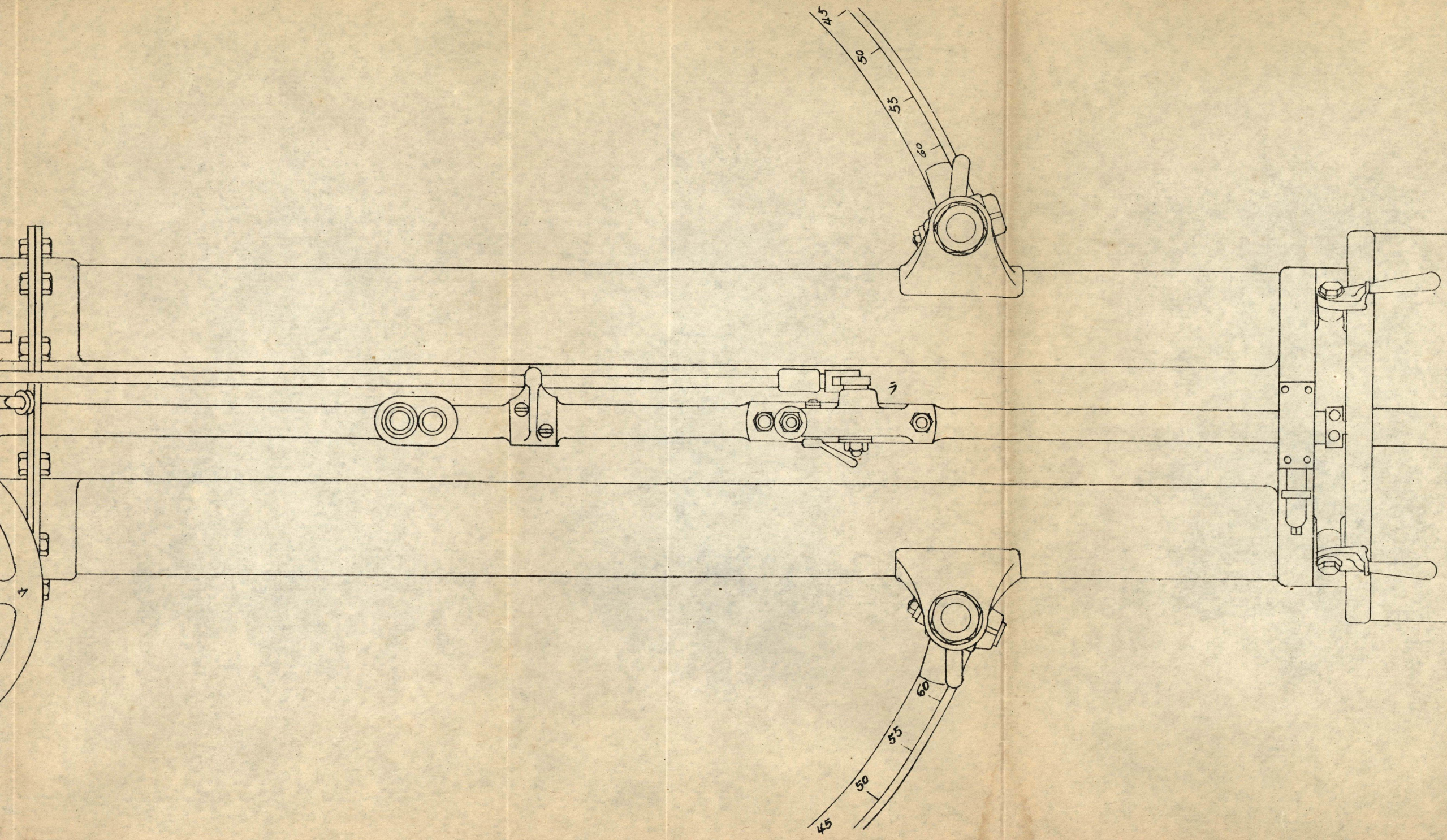

+

