

海軍機關學校

機關學教科書機關計畫大要

附圖 第三學年



大正四年一月



3A
87

第一圖

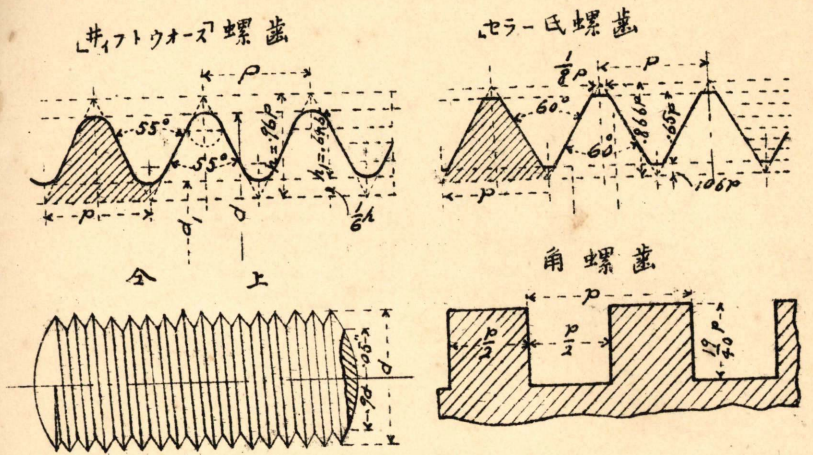

第二圖

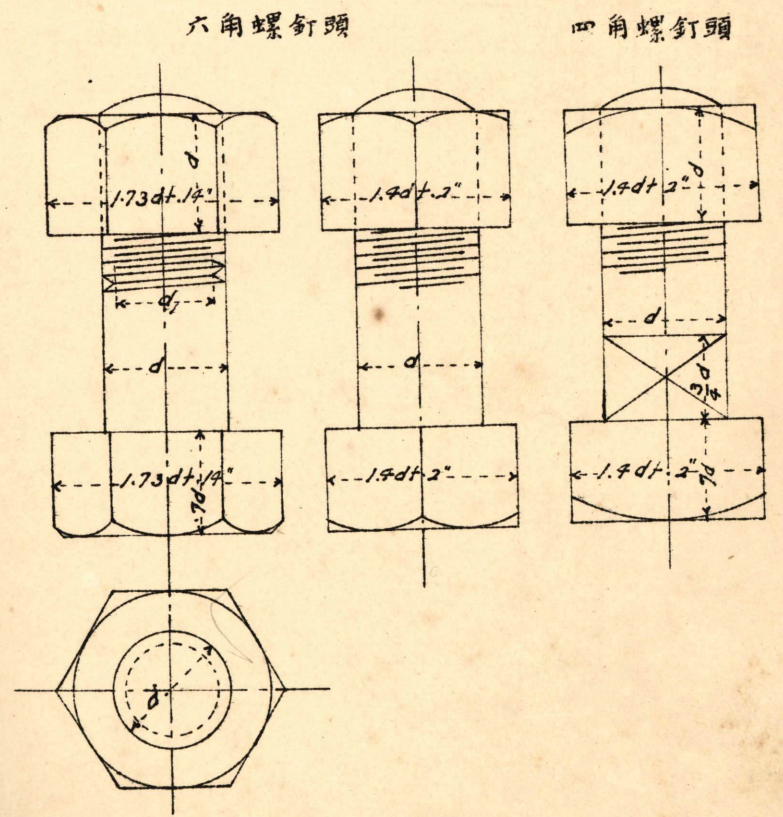

第三图

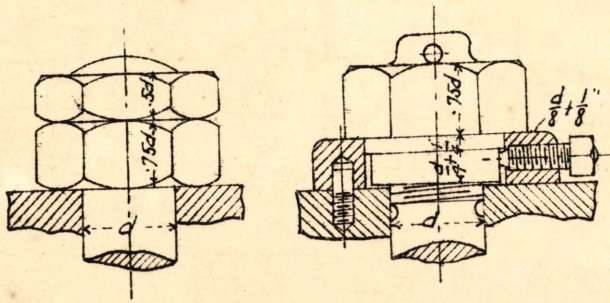

第四图

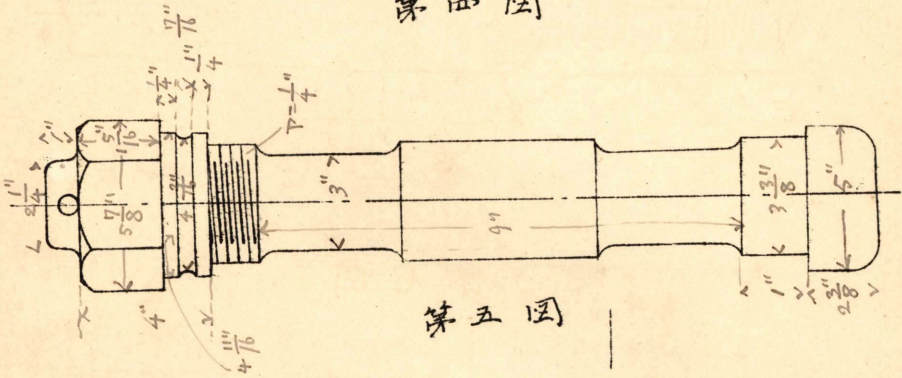

第五图

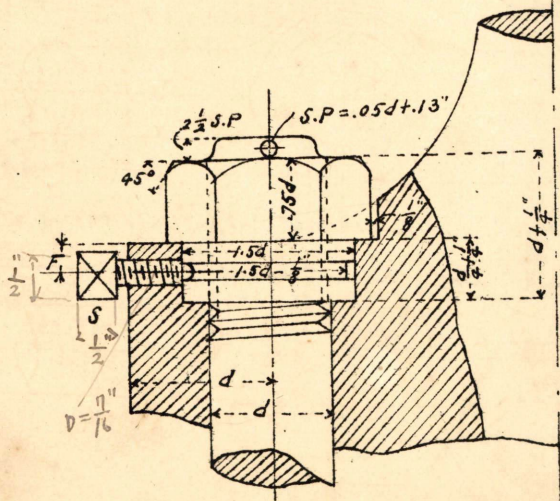

$S.P = \text{Split pin}$
 $S = \text{Sat screw}$
 $S = \frac{1}{8}d + \frac{1}{8}''$
 $F = S$

第六图

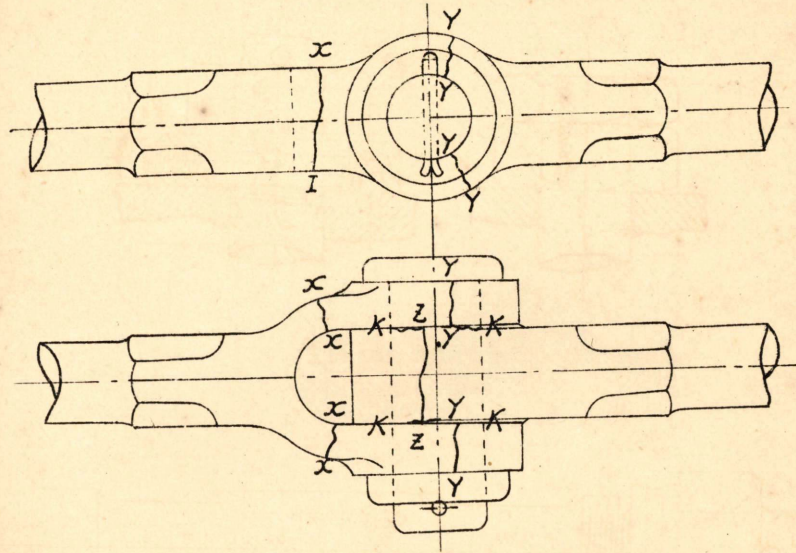

第七图

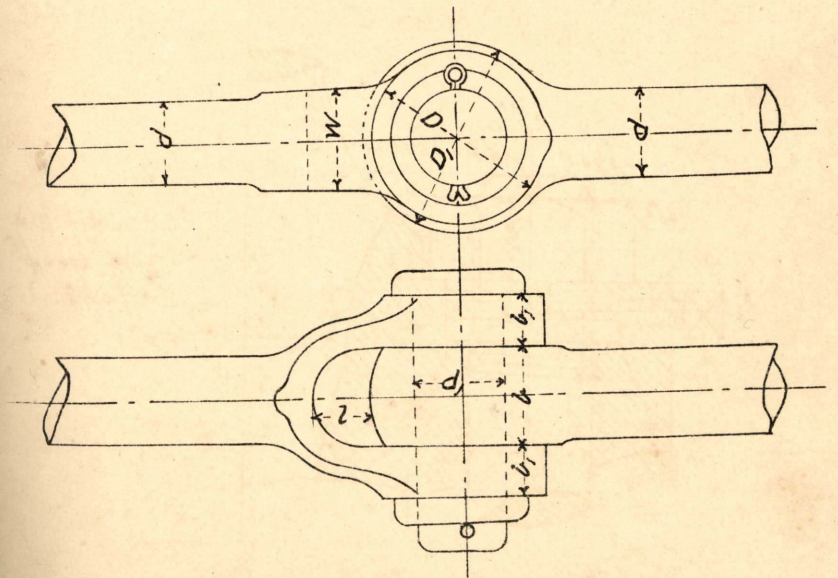

第八图

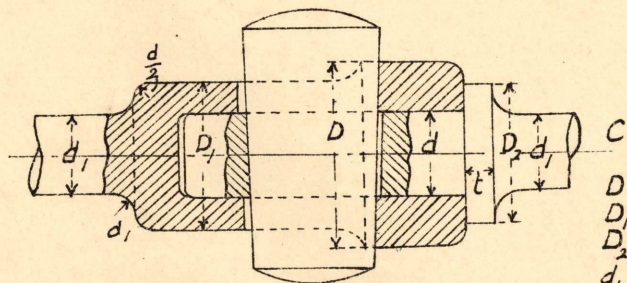
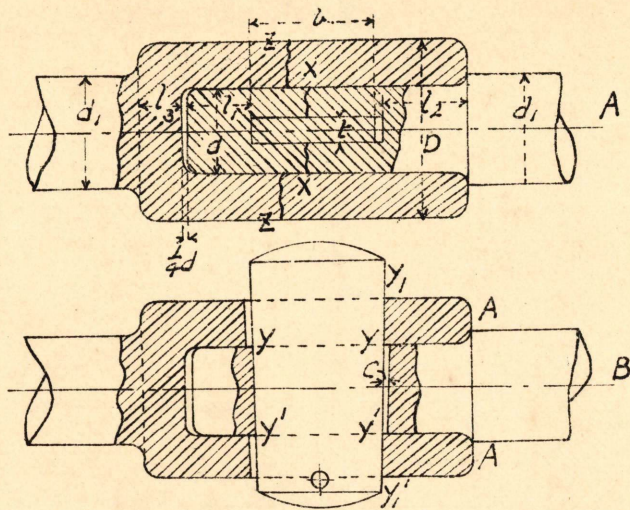

第九图

$$\begin{aligned}
 D &= 2.4d_1 \\
 D_1 &= 2d_1 \\
 D_2 &= 1.5d_1 \\
 d_1 &= .82d \\
 t &= .5d_1
 \end{aligned}$$

第十图

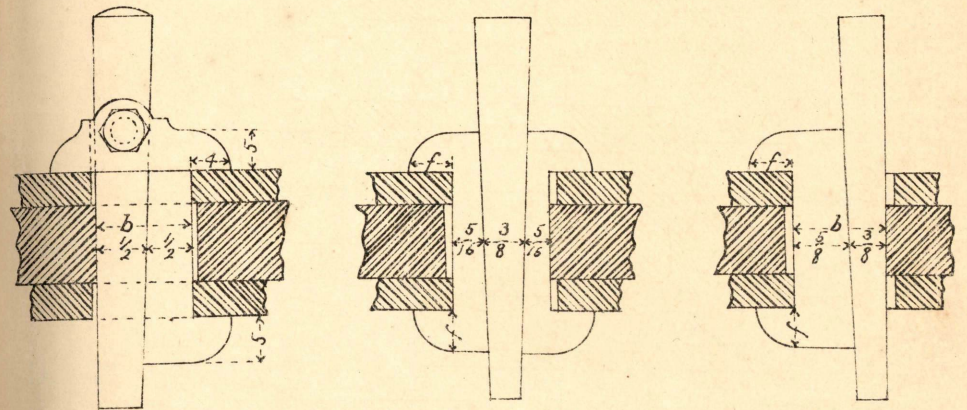

第十一图

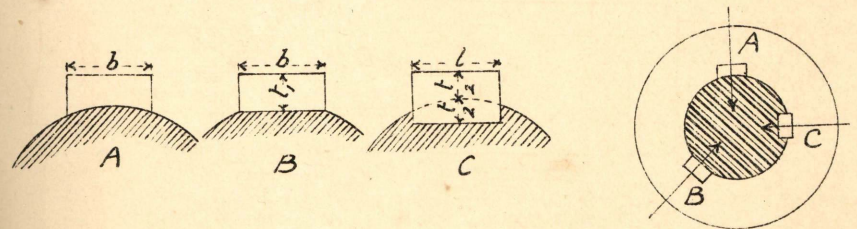
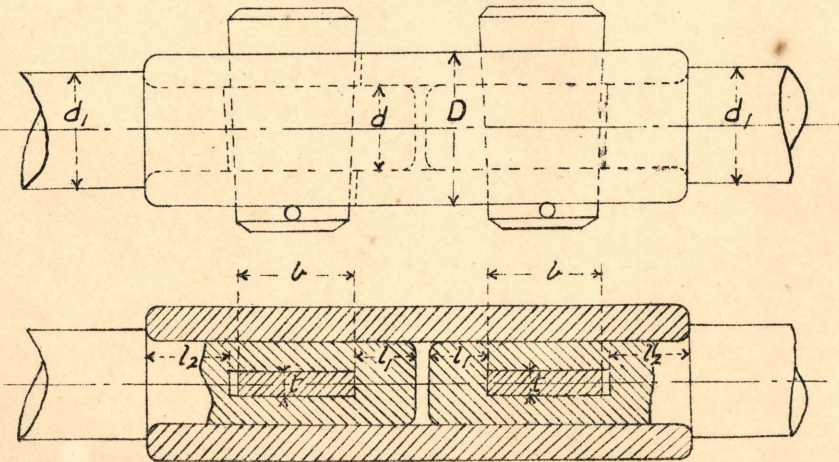

第十四图

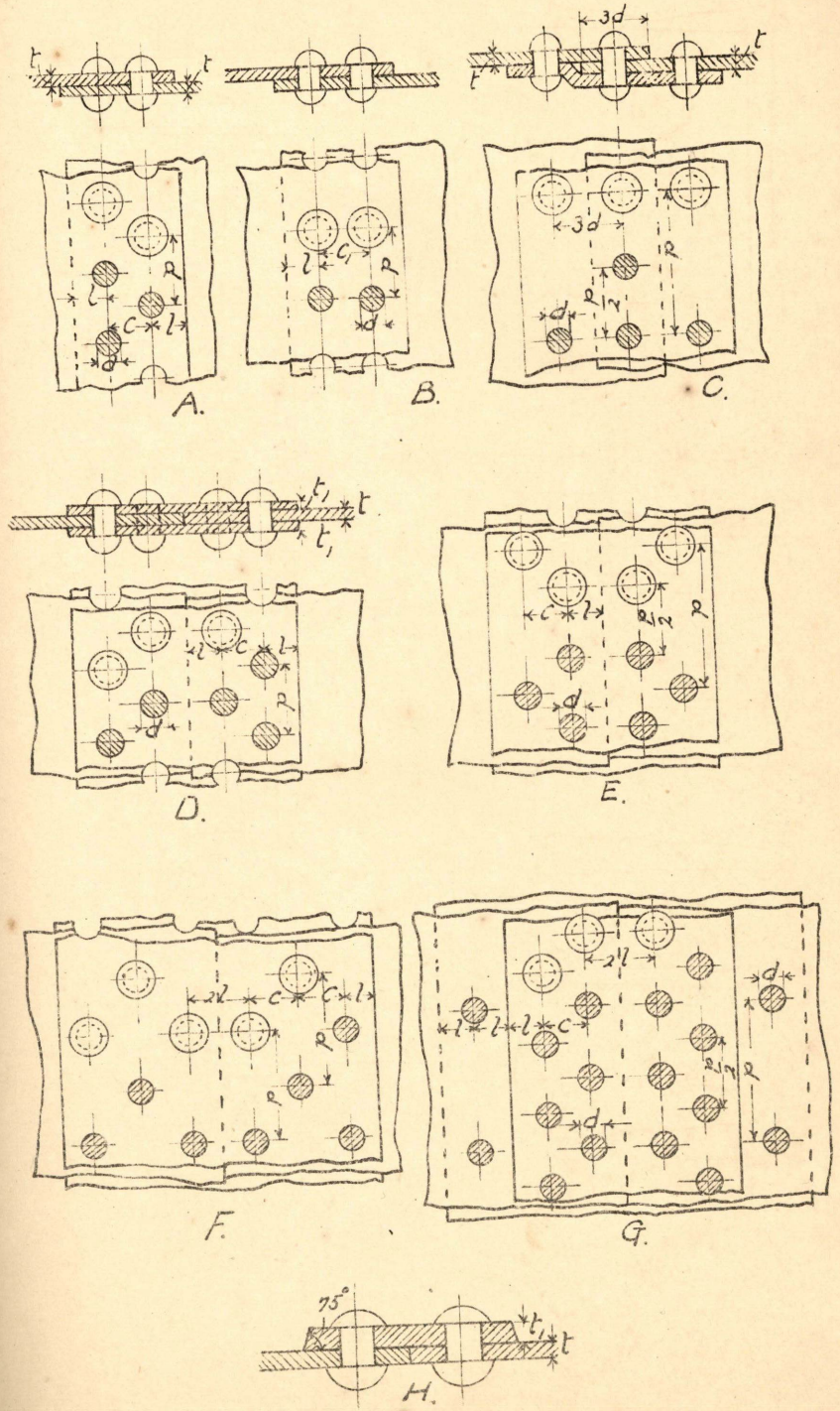

第十二图

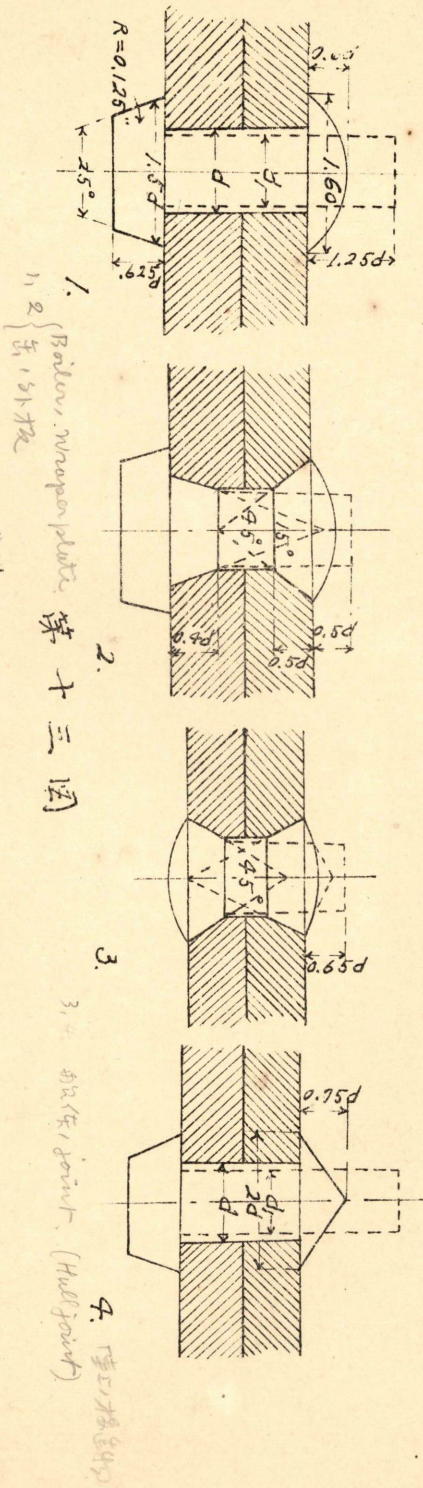

1. Roller, inorganic plate
 2. Roller, inorganic plate
 3. Roller, inorganic plate
 4. Roller, inorganic plate

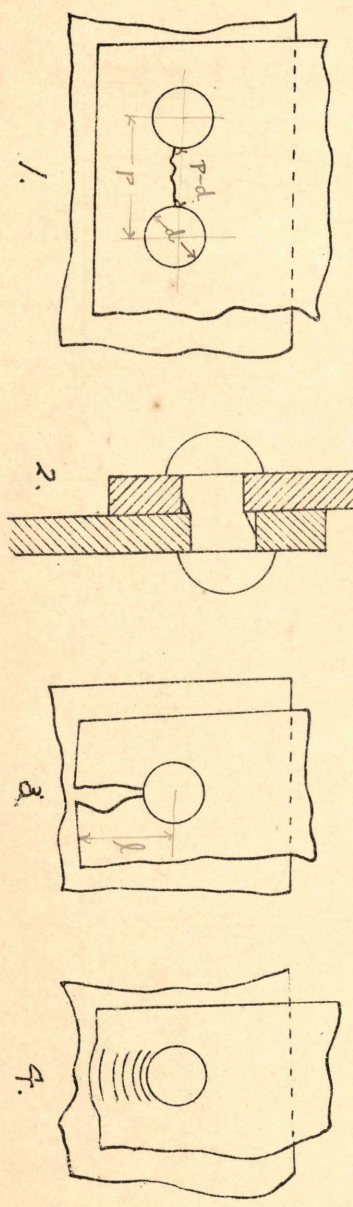

第十五图

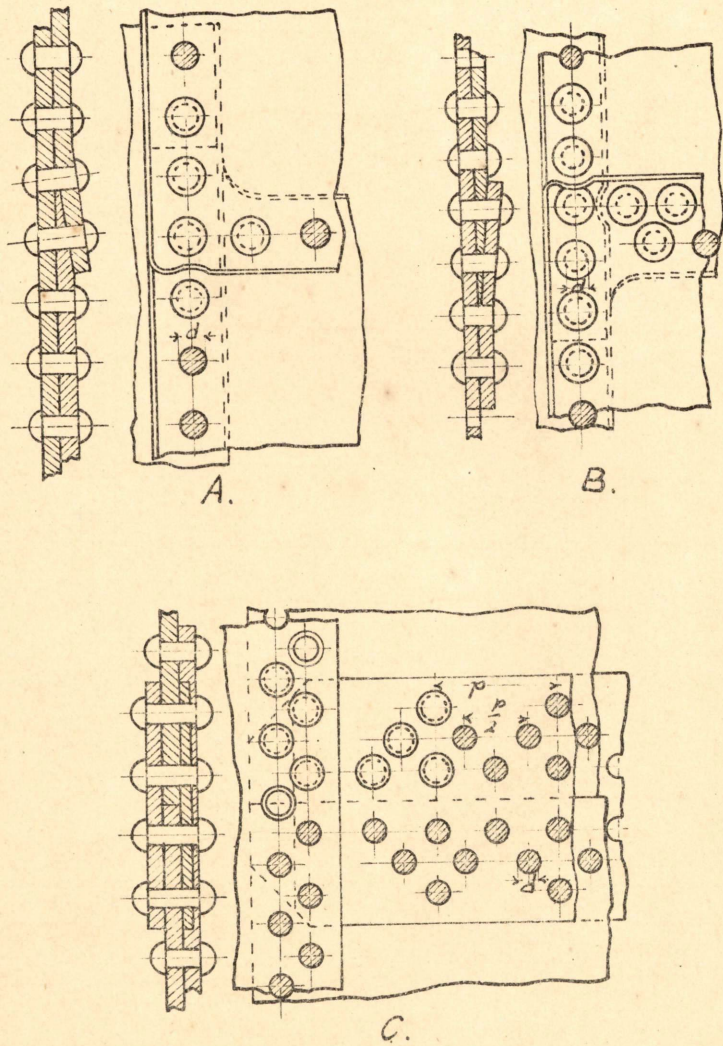

第十六图

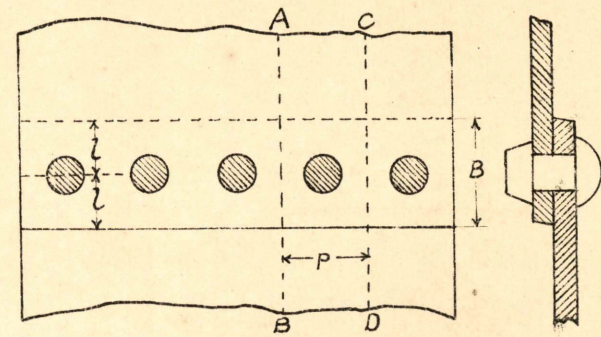

第十七图

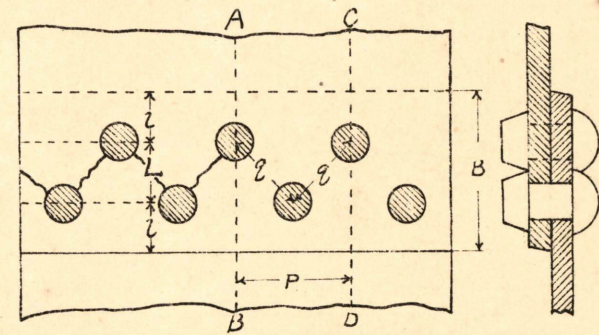

第十八图

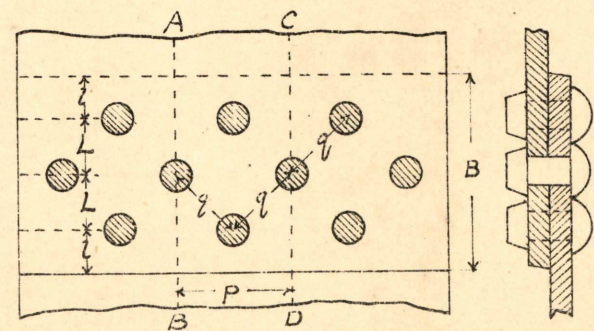

第十九图

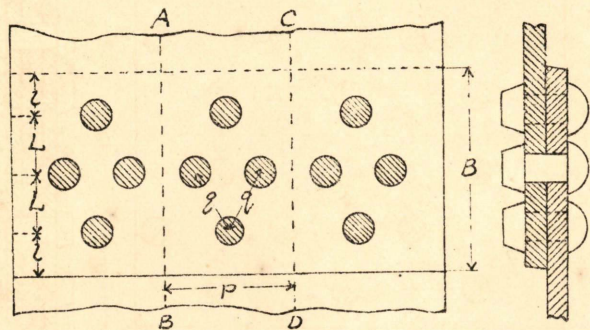

第二十图

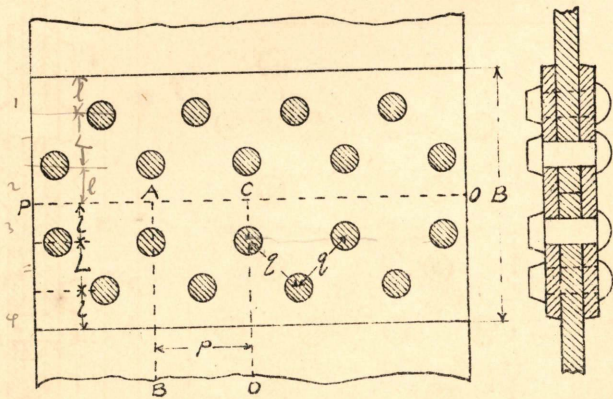

第二十一图

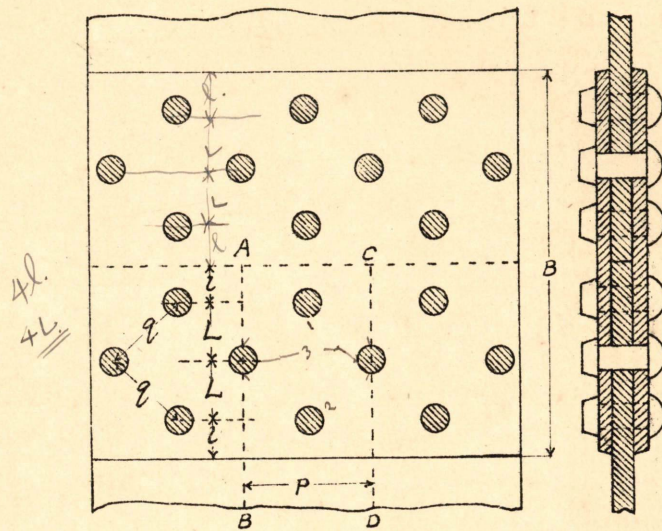

第二十二图

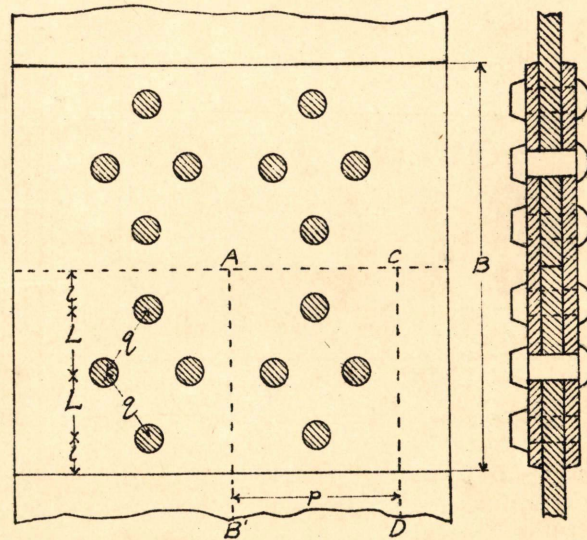

第二十三图

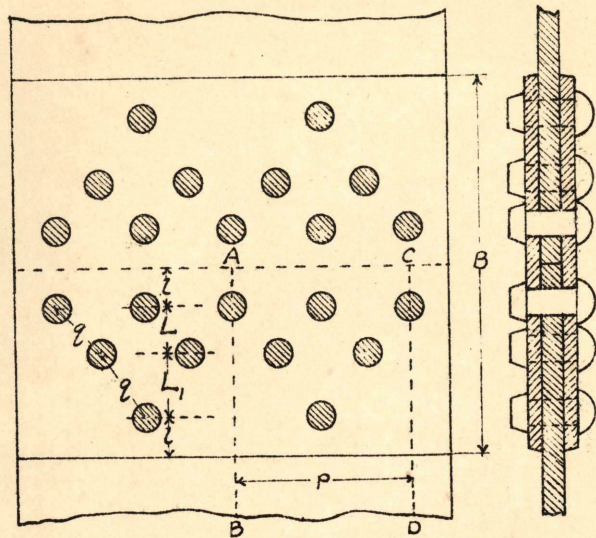

第二十四图

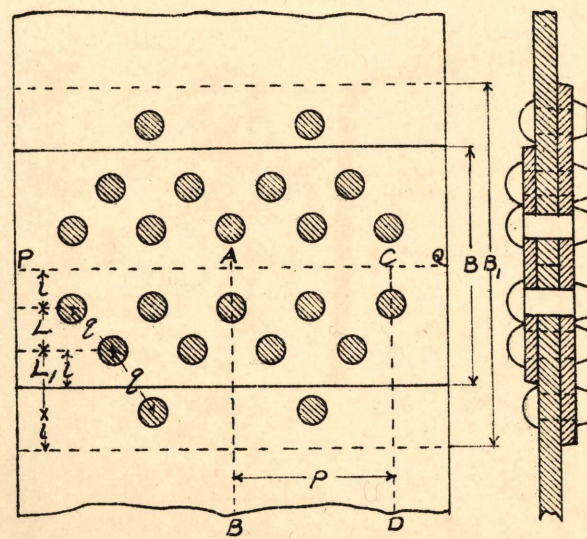

機關計畫第二十五图

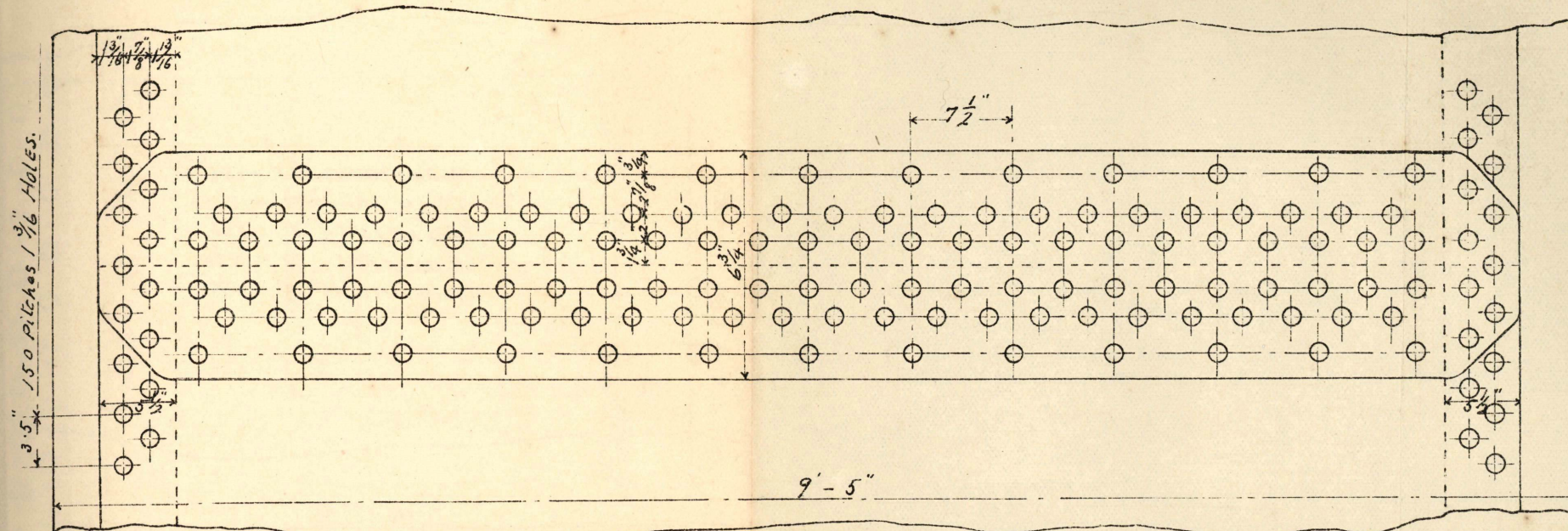

Working pressure. W.P. = $155 \frac{165}{16}$ Dia of boiler. D = 14'-0" Pitch of rivet. p = $7 \frac{1}{2}$ "
 Dia of rivet. d = $1 \frac{1}{8}$ " Thickness of plate t = $1 \frac{1}{16}$ "

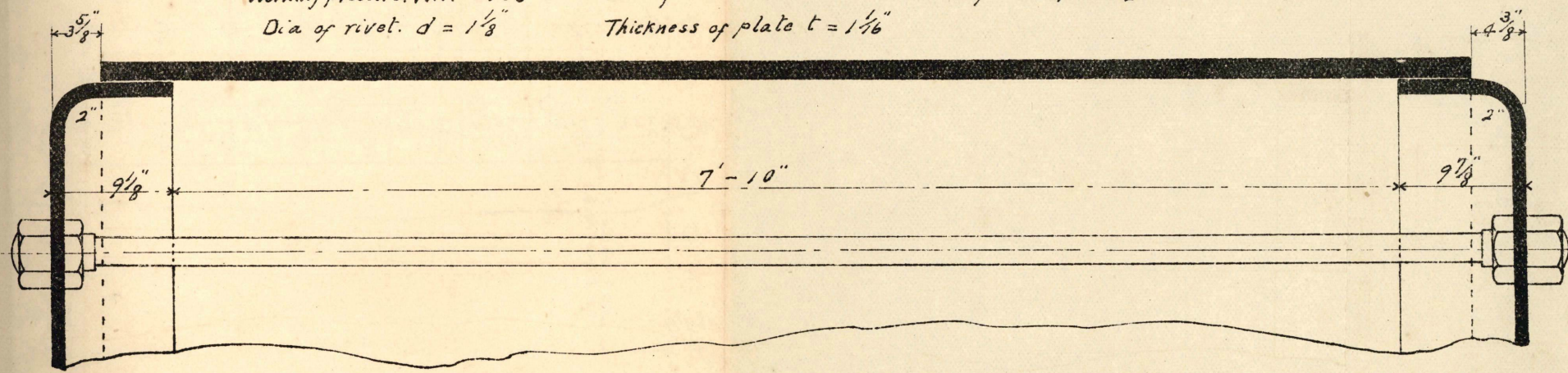

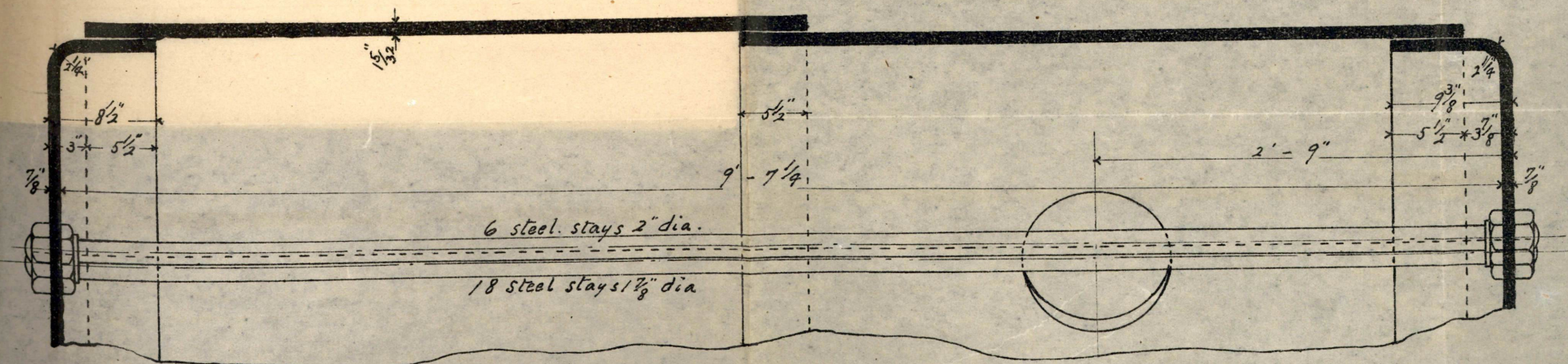
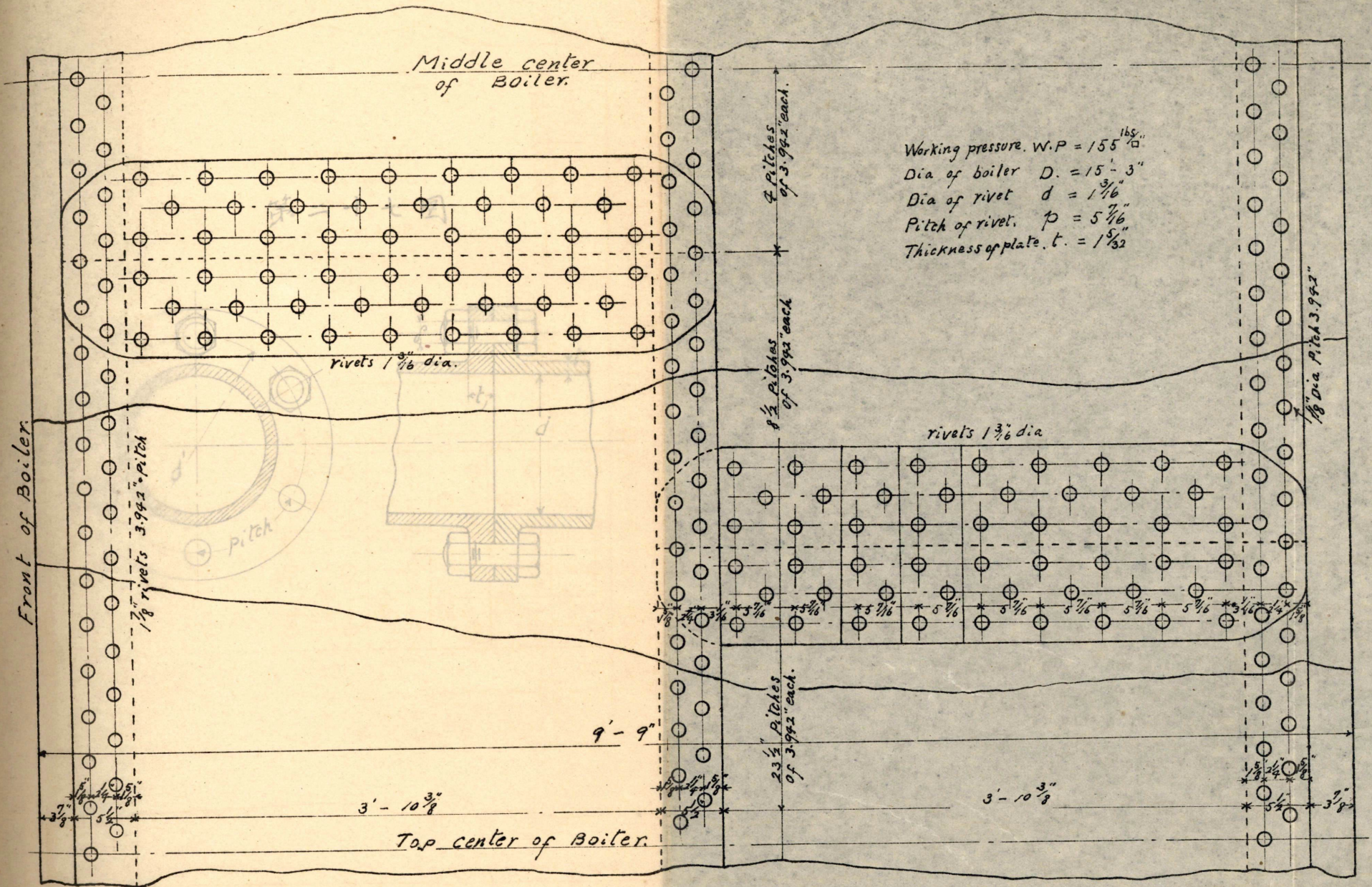

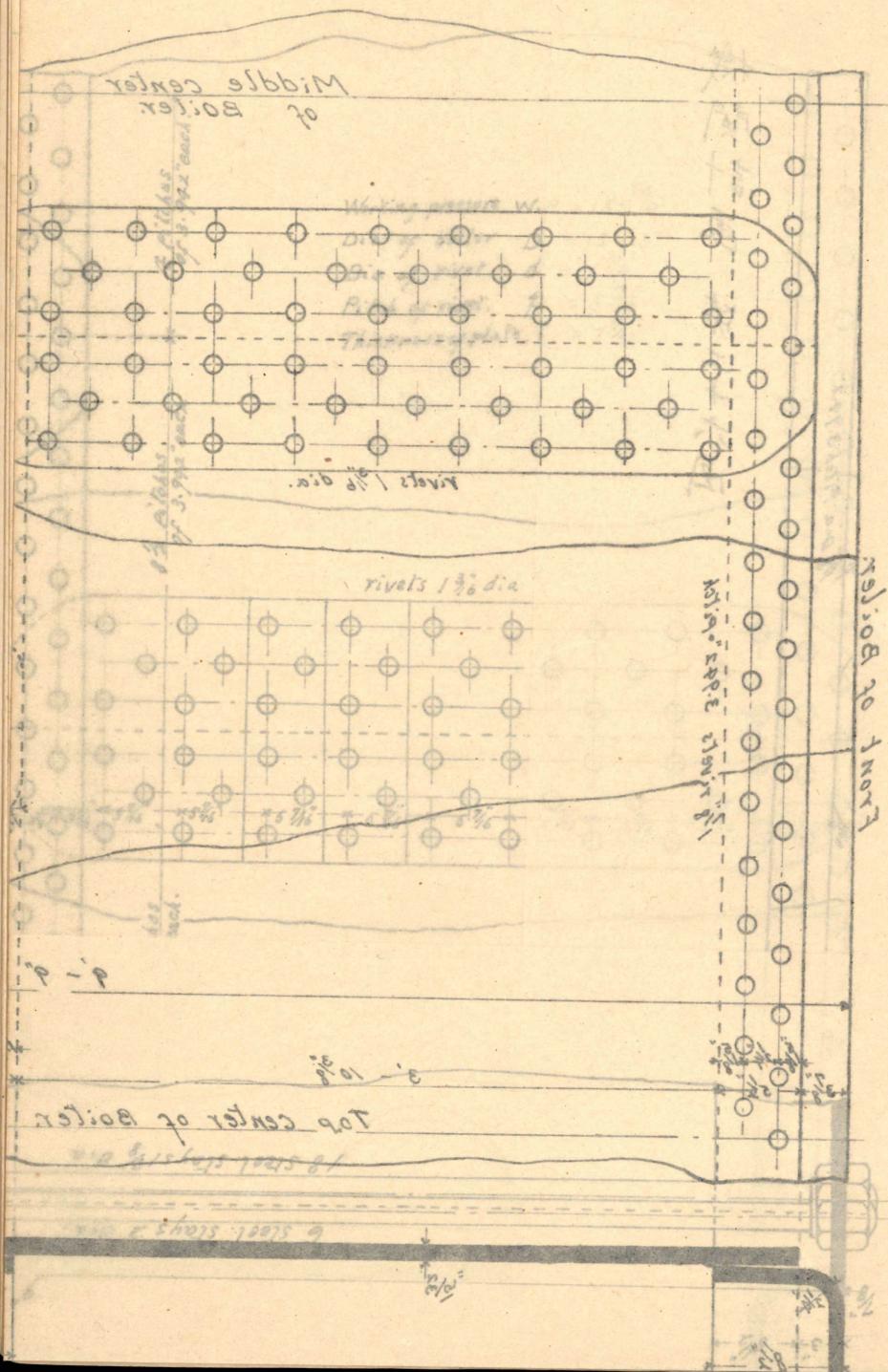

第二十七圖

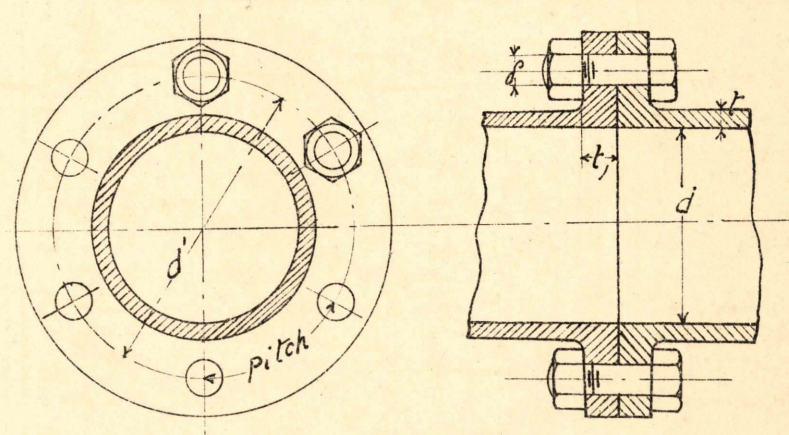

第二十八图

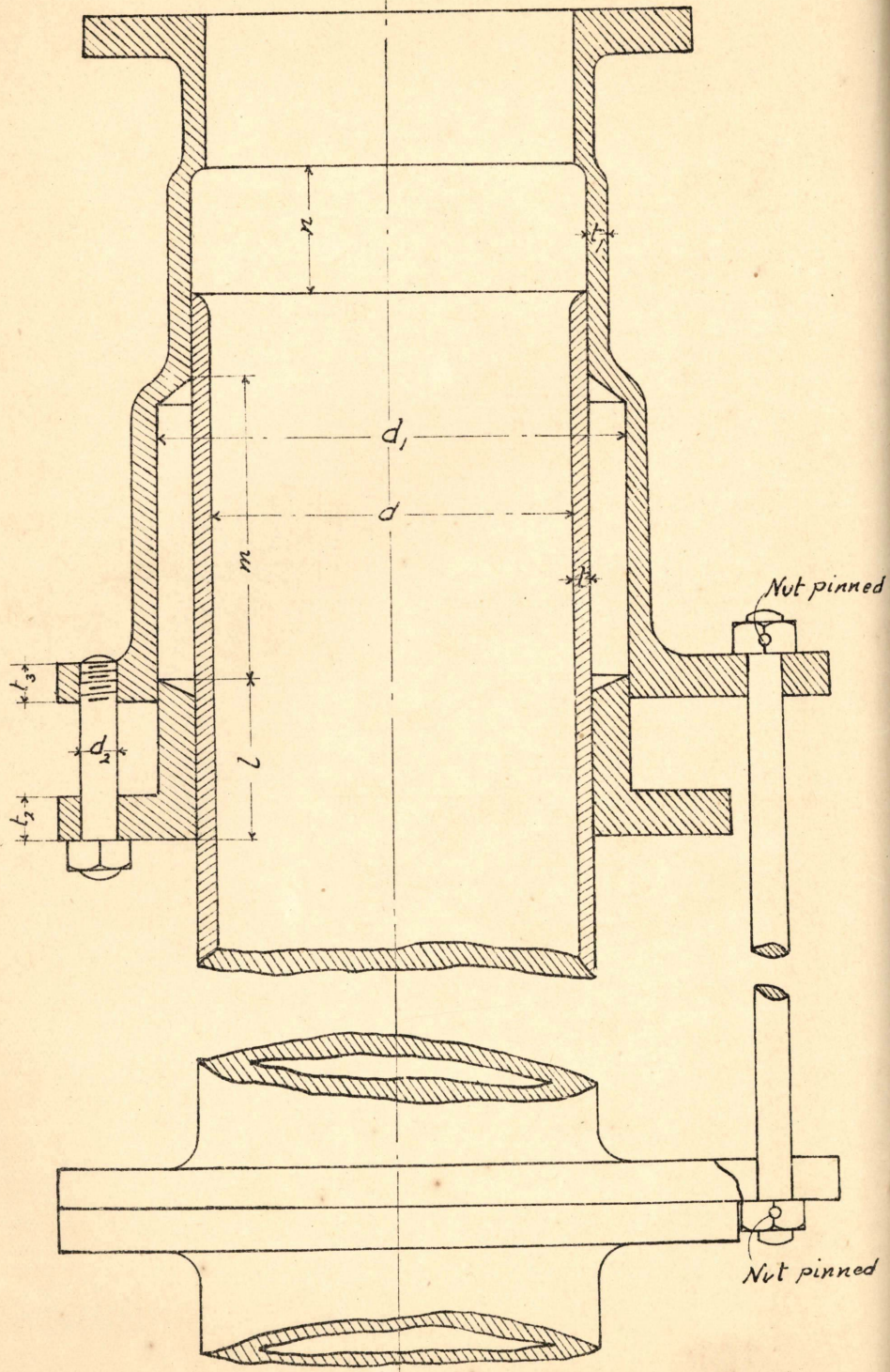

第二十八图一

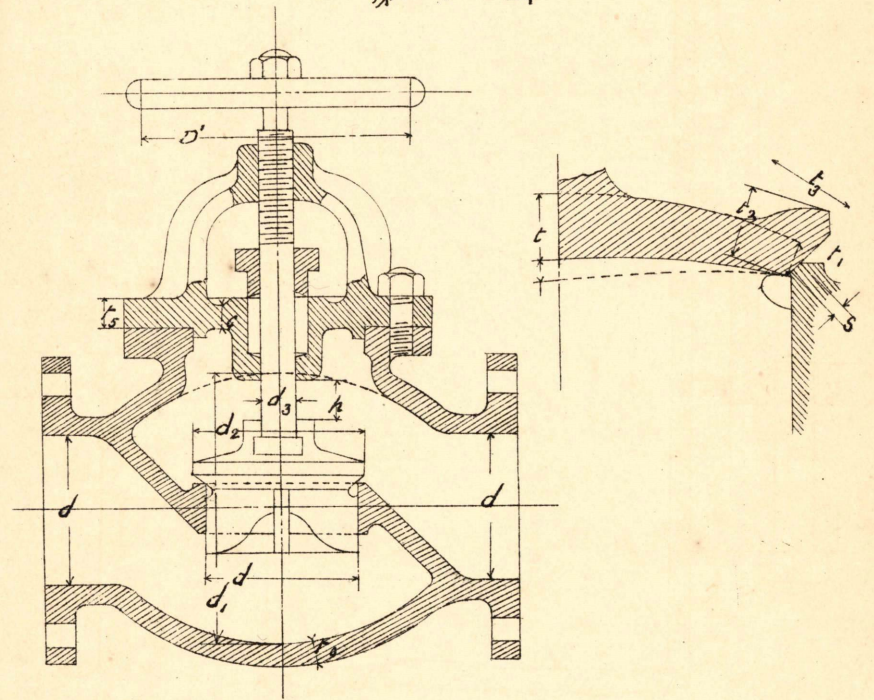

第二十九图

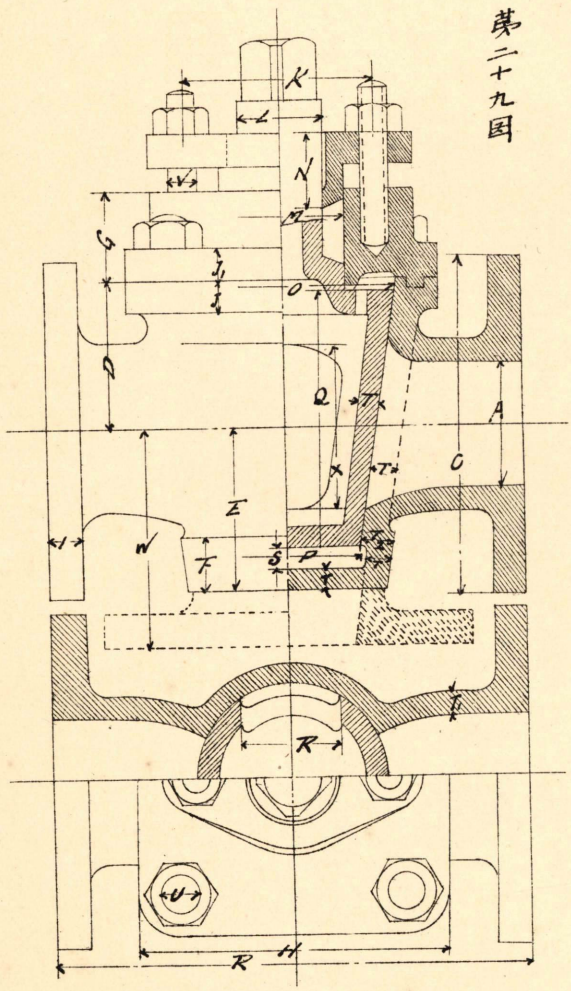

第三十图

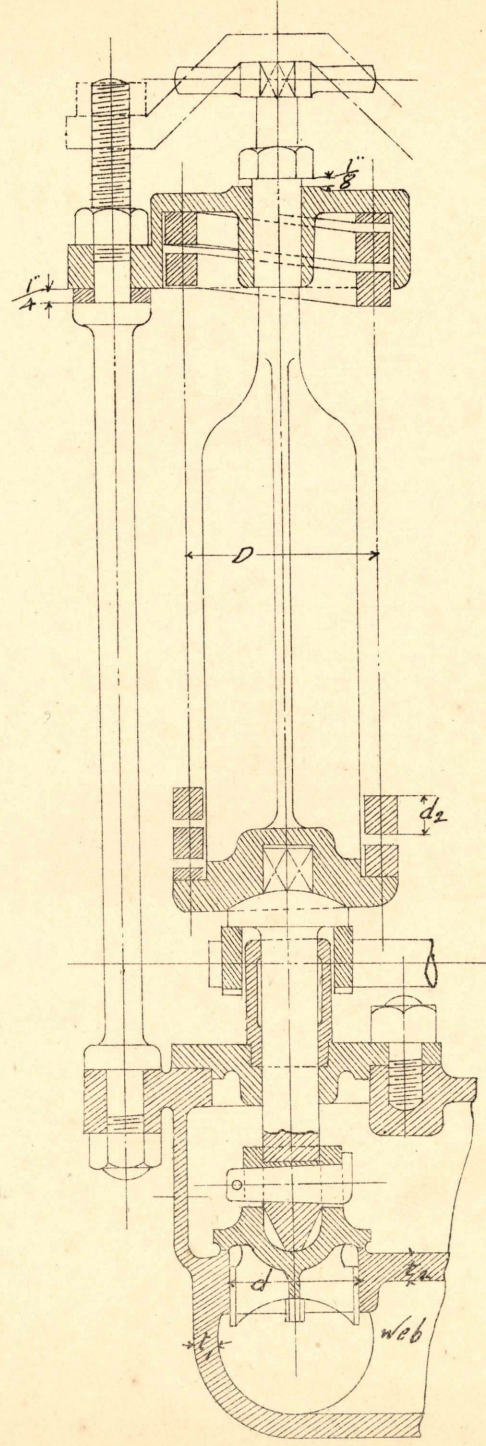

第三十一图

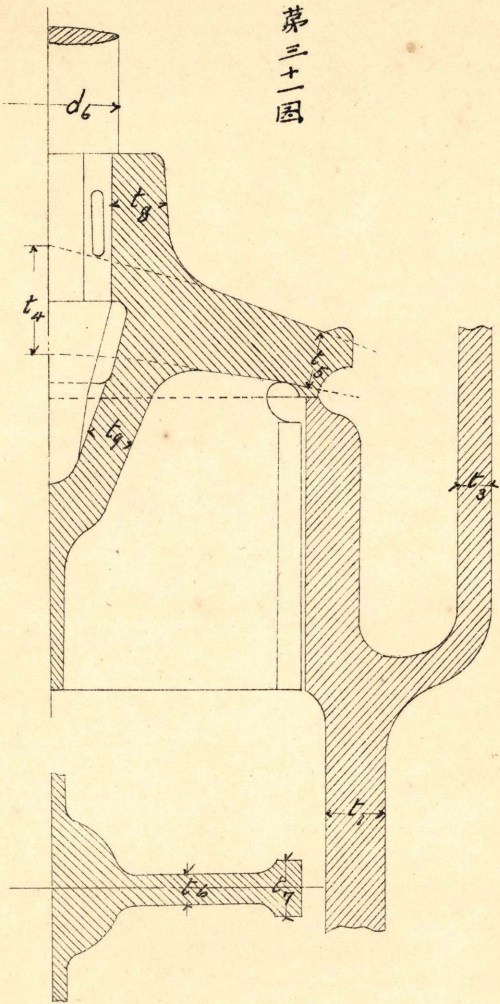

第三十二图

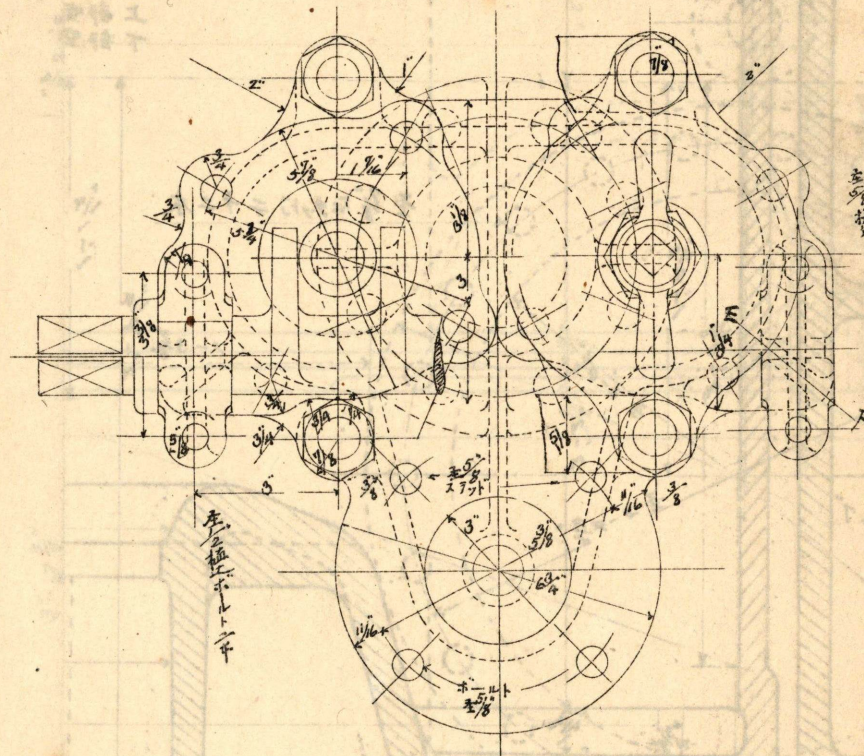
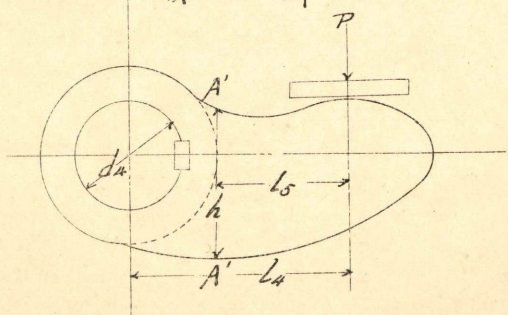

A-B 切断面

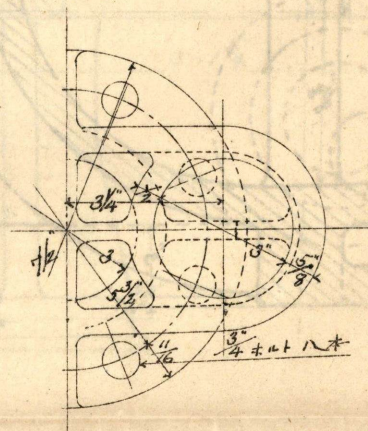

卷條重要寸法	
卷條，大	13/16
卷條平均直徑	4 3/4
口，片，數	13
伸強，片	10 3/4
壓縮，片	15 3/4
荷重	1661

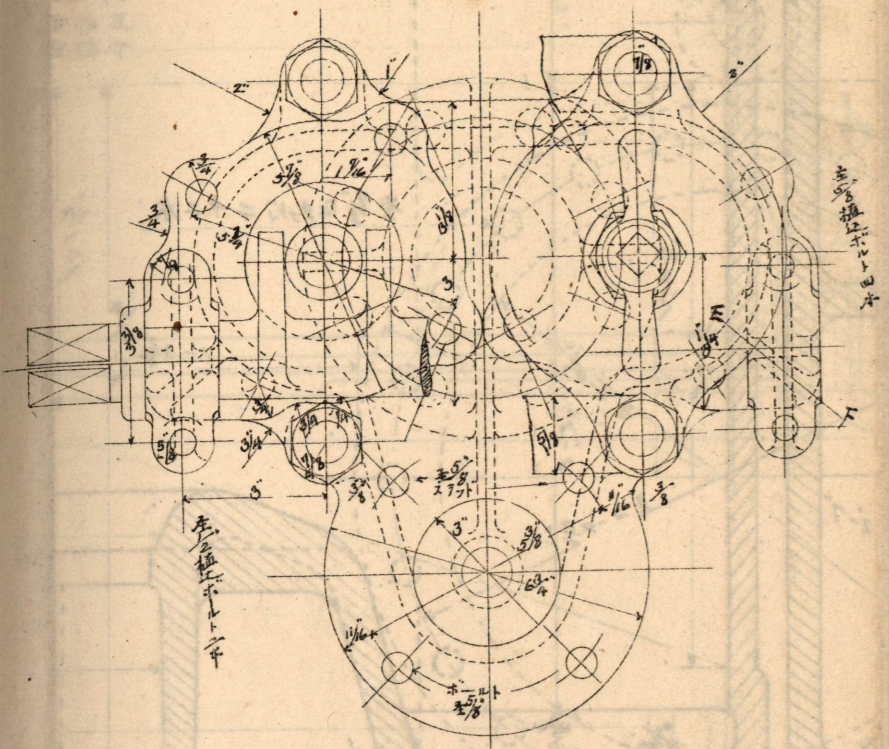

AB切斷面

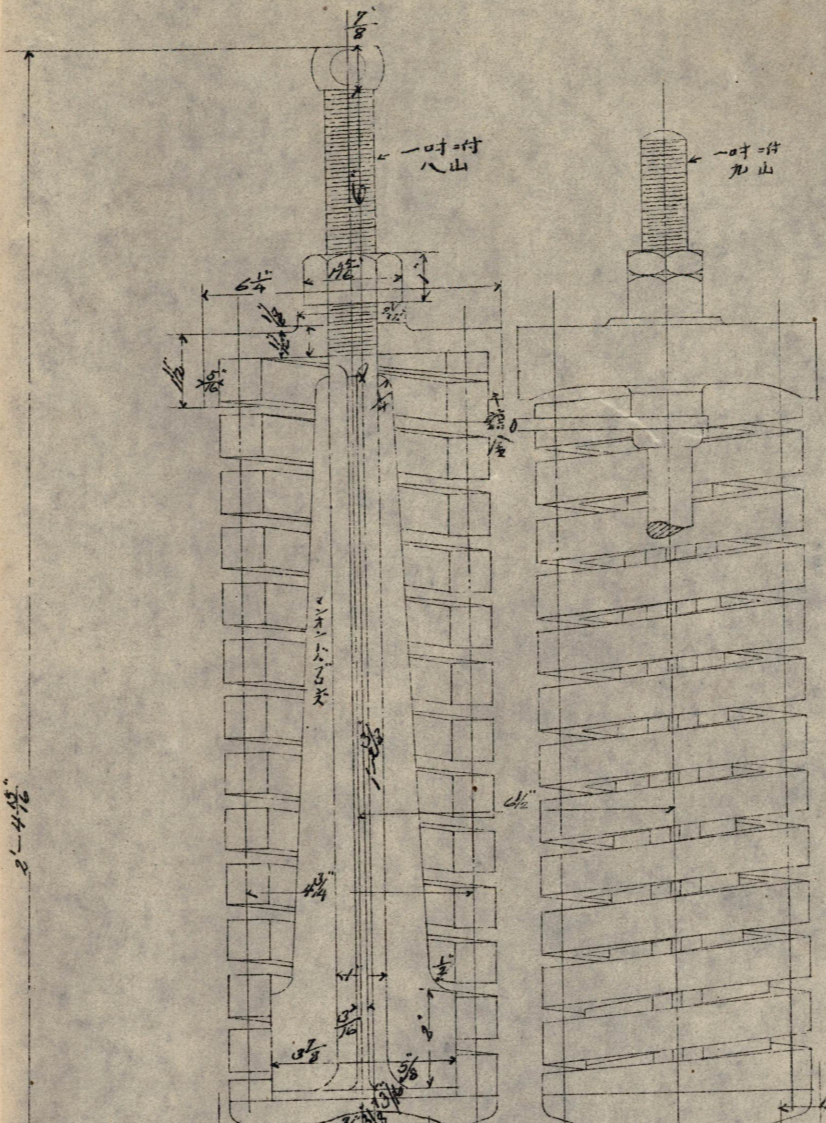
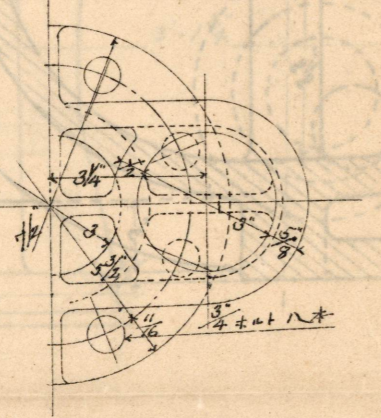

C.D切斷面

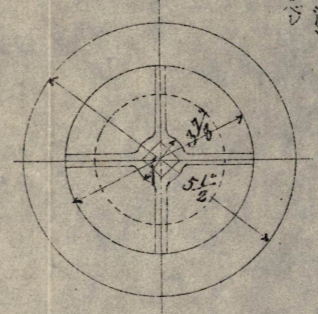

此部分厚，可與調整上通風定。

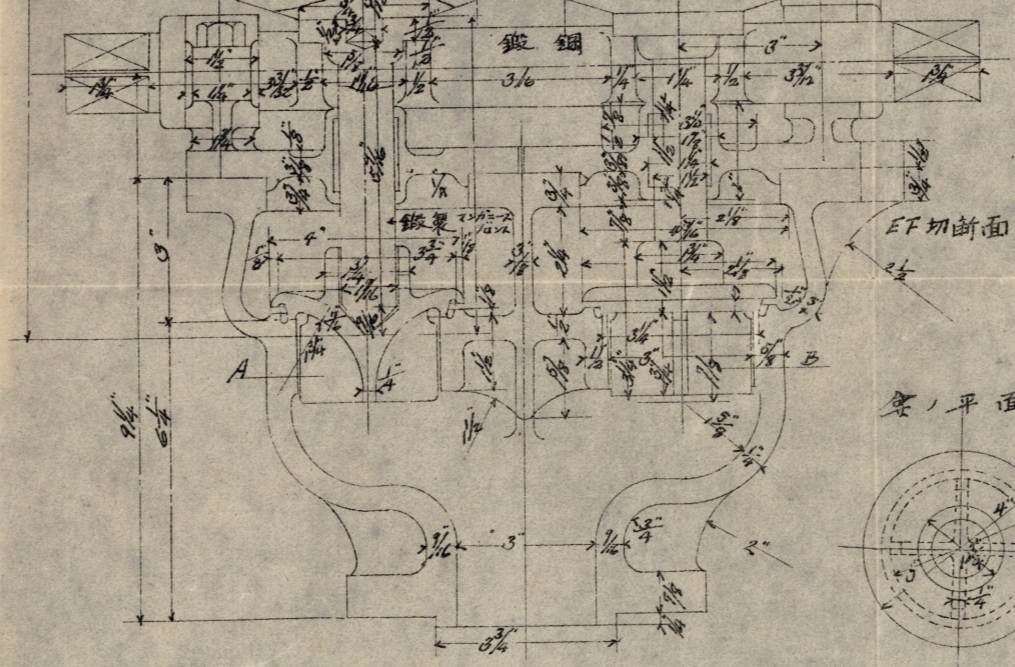

寬，平面

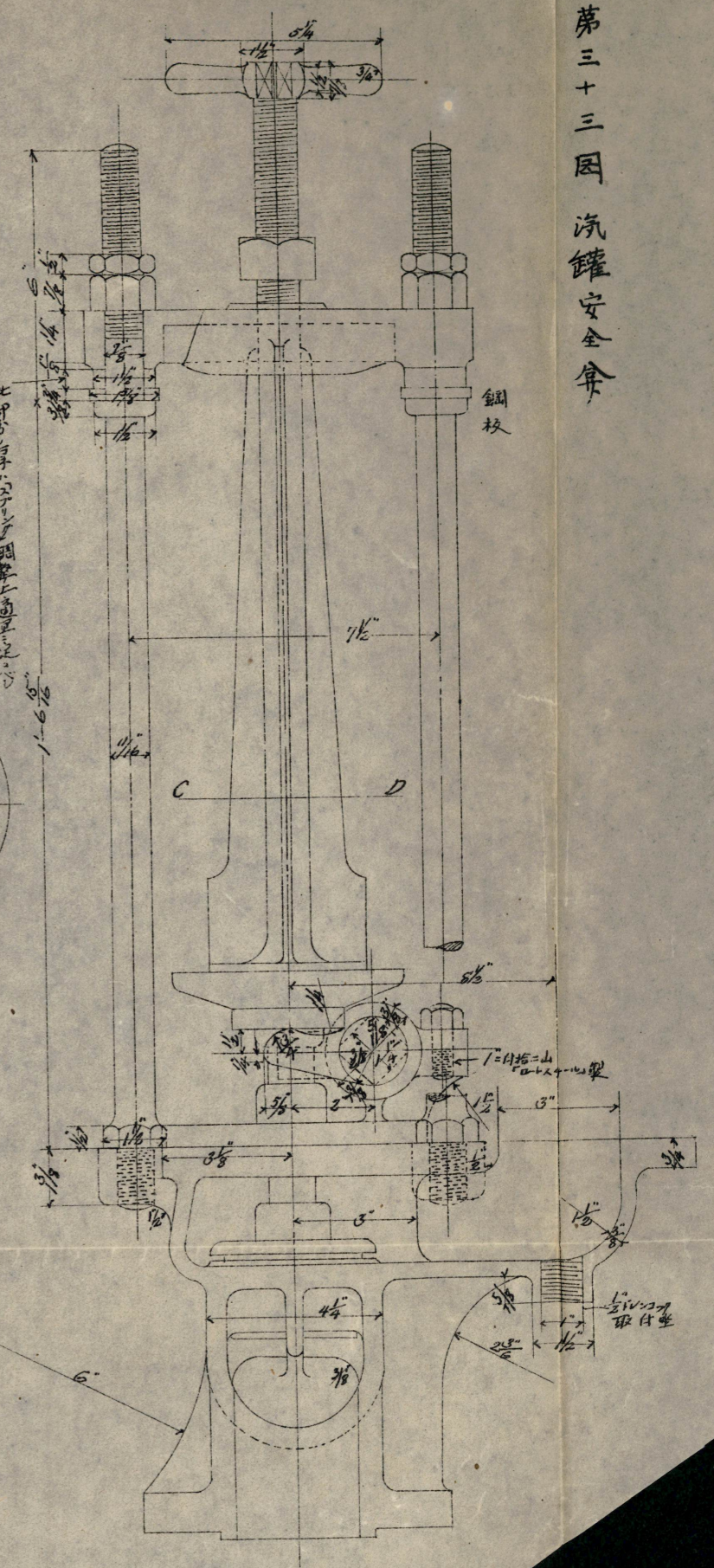

EF切斷面

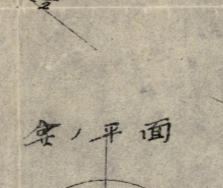

鋼板

與汽罐取付處

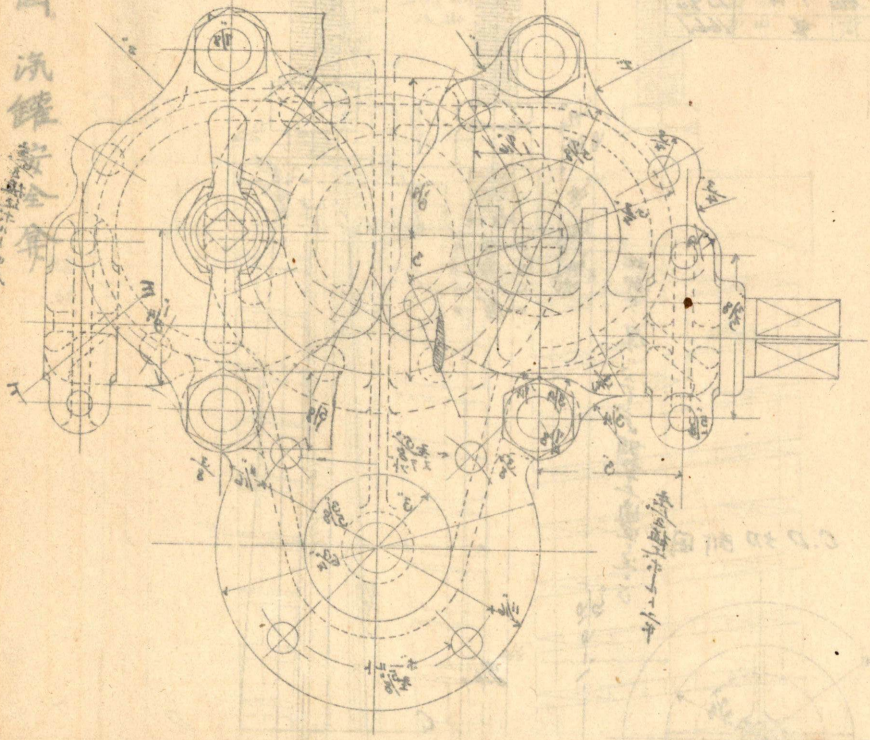

汽缸安全角

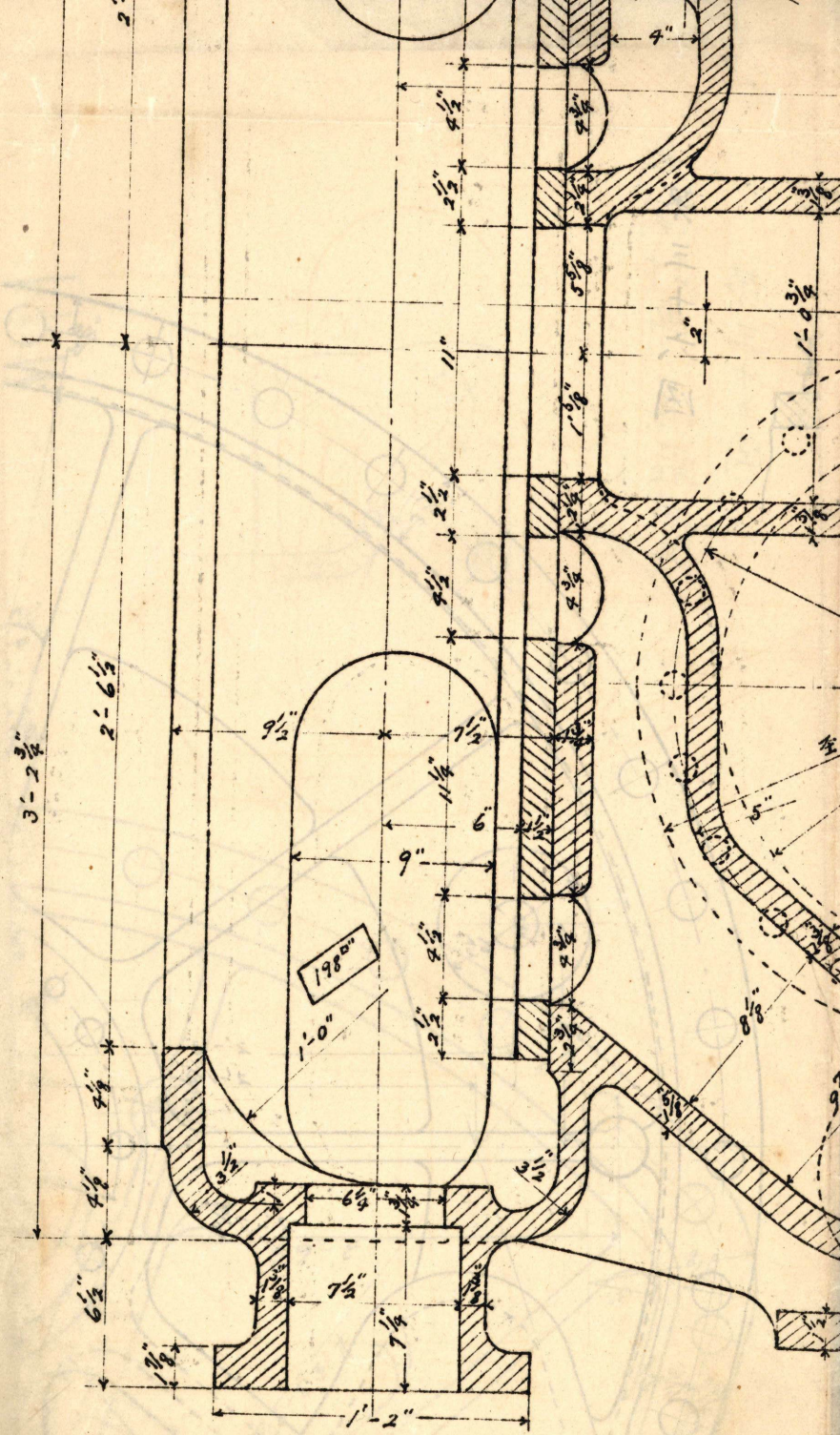
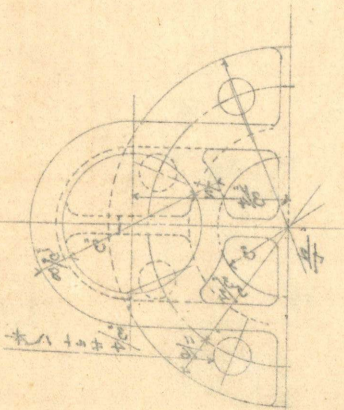

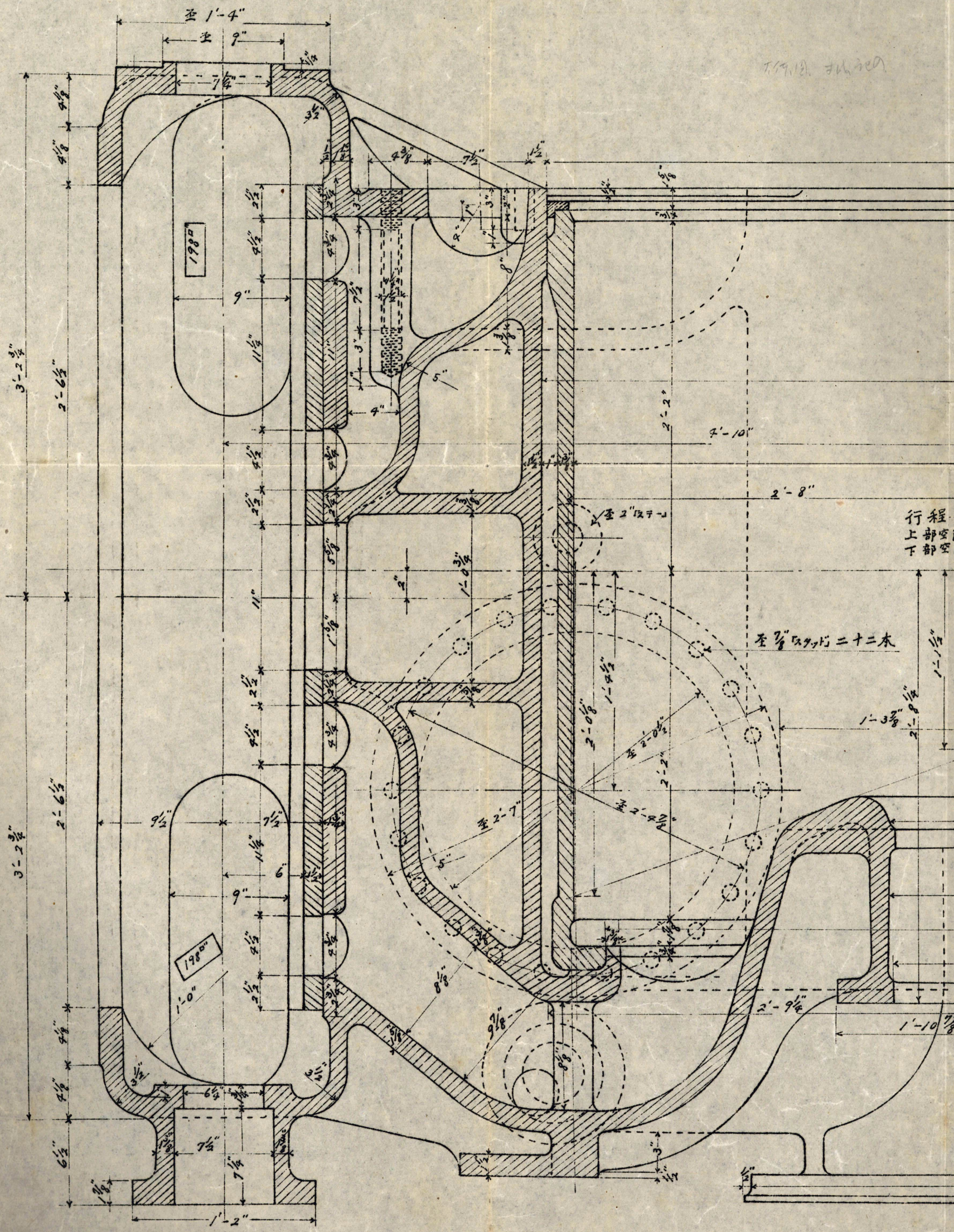

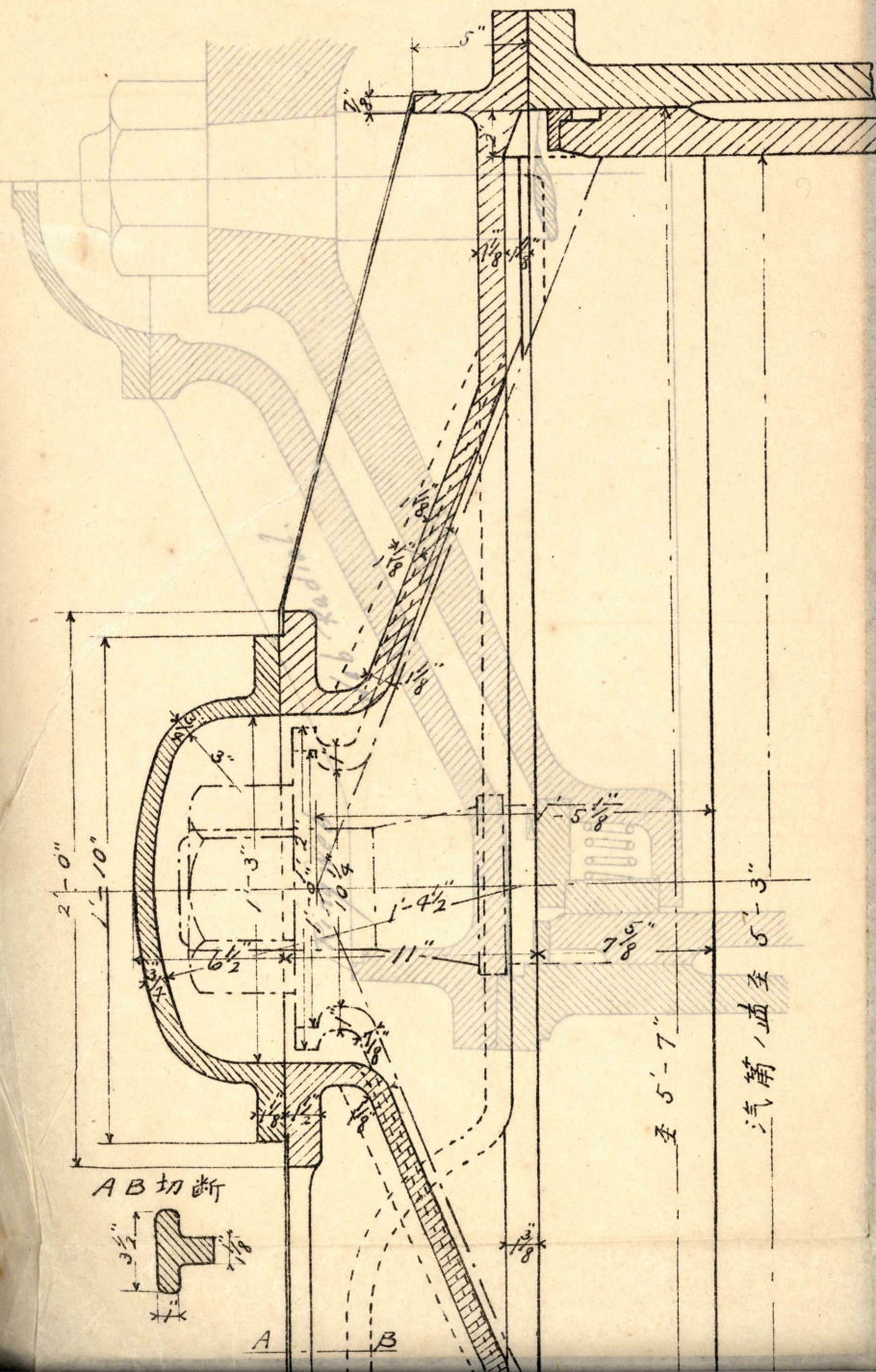
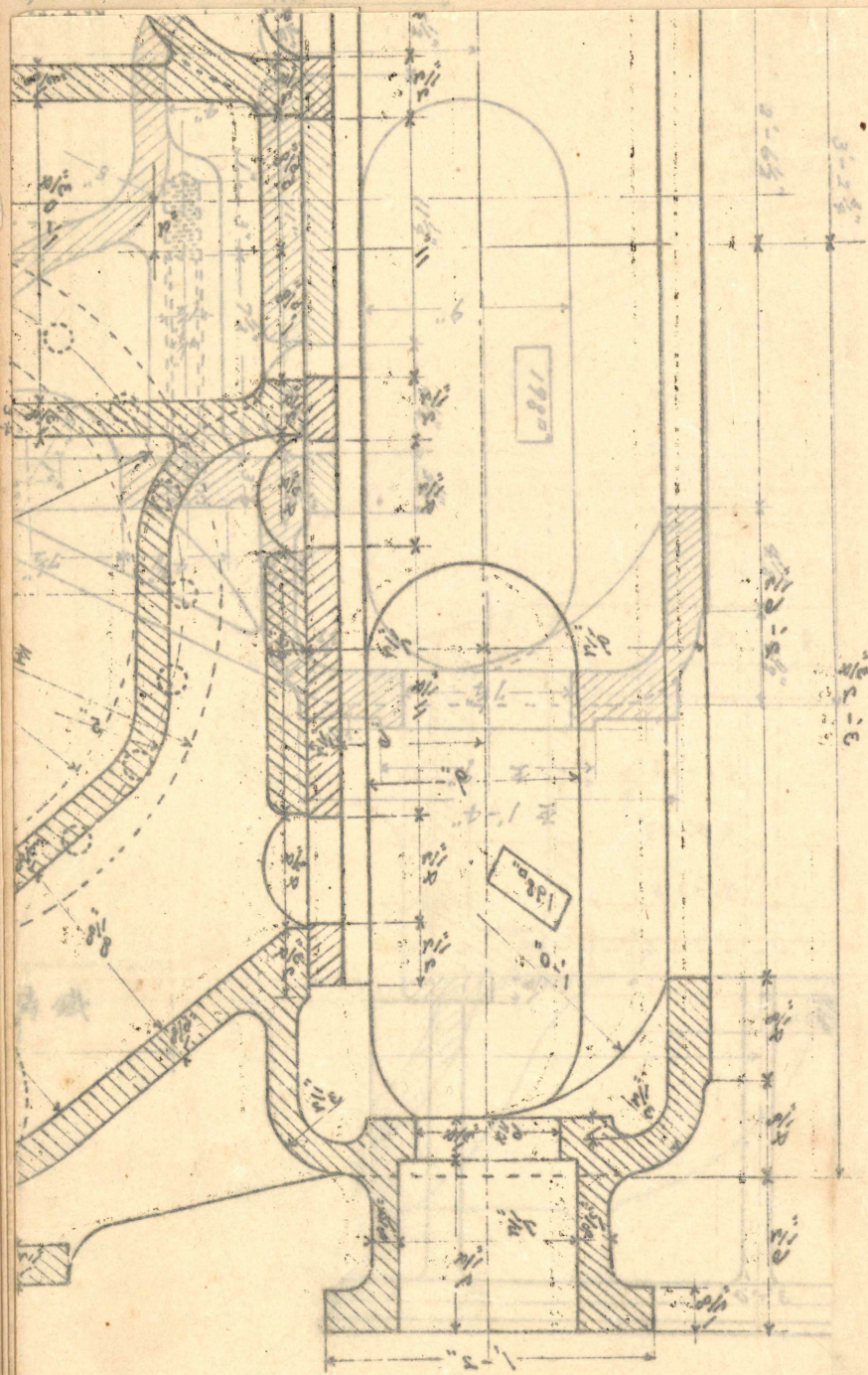

第三十六图

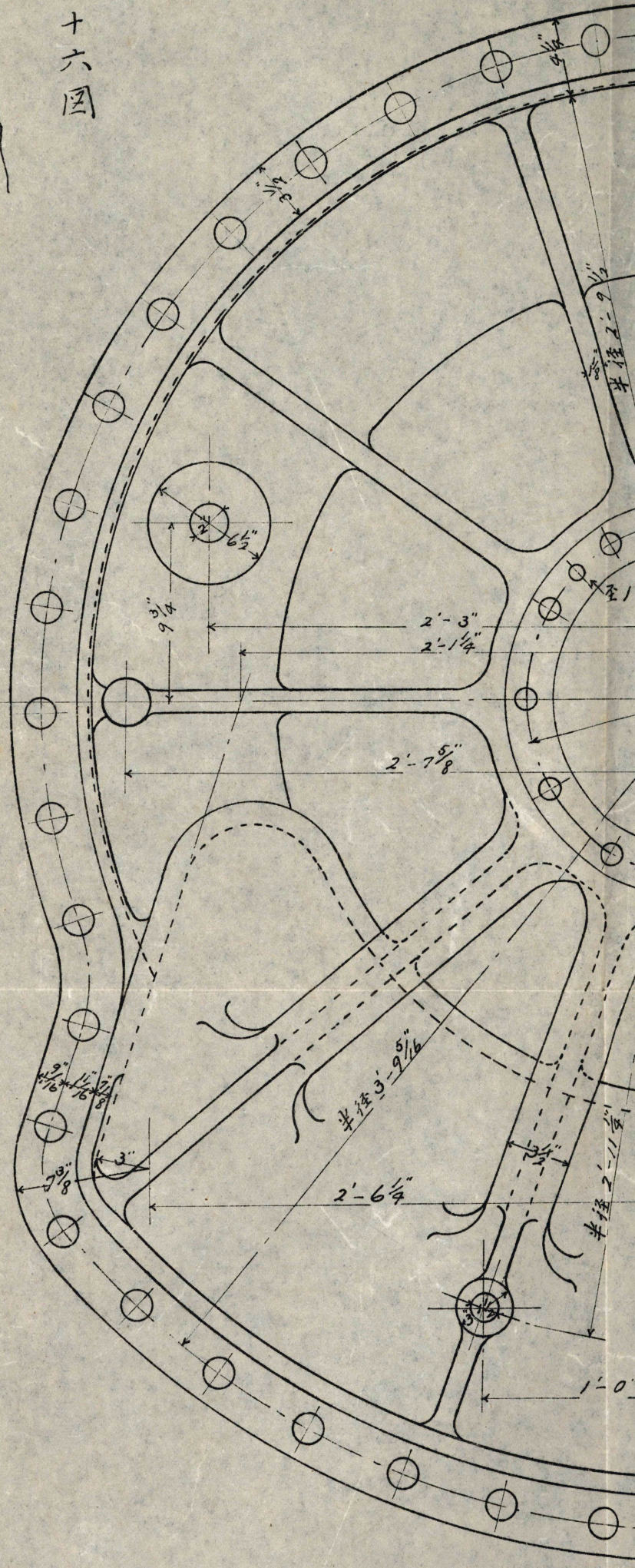
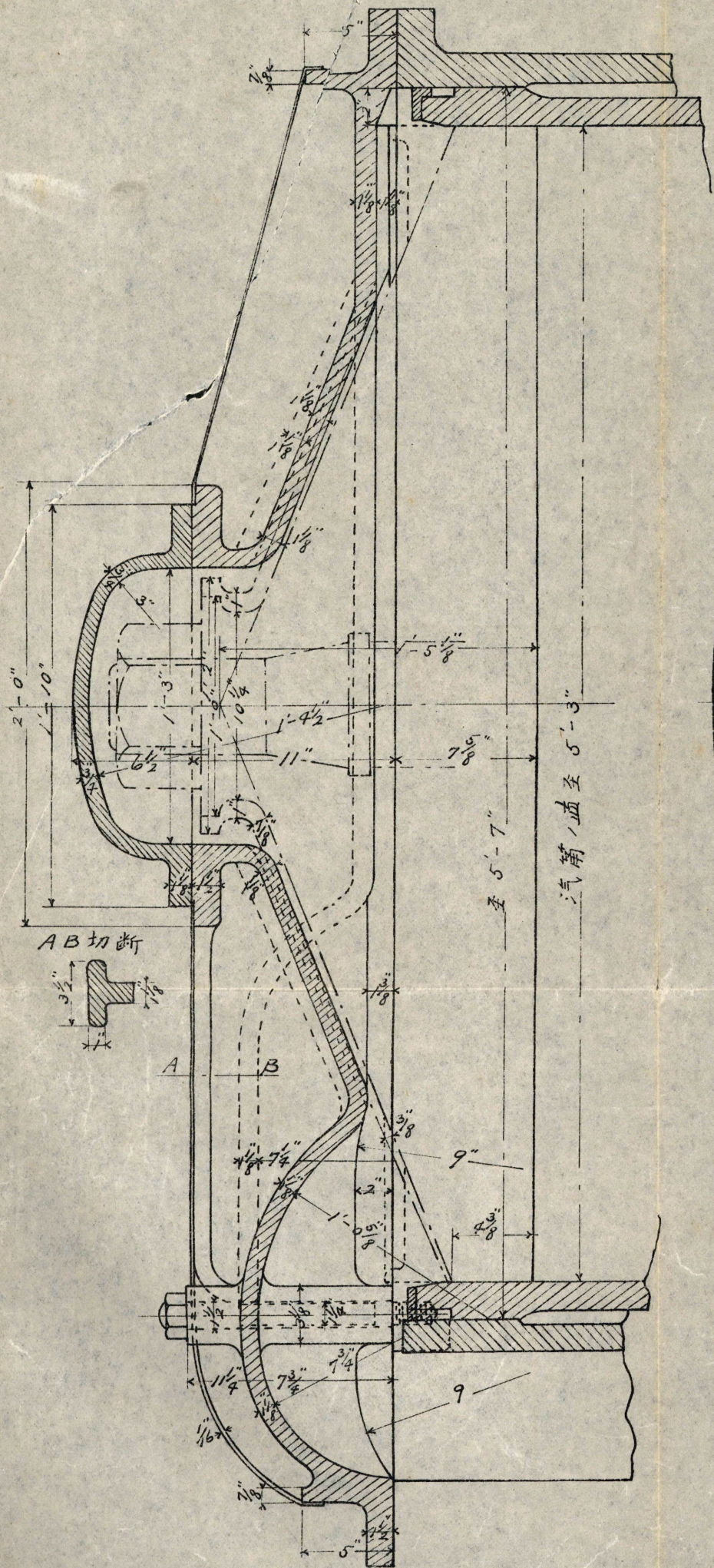

機関計畫 低壓用汽筒蓋
第三十五圖

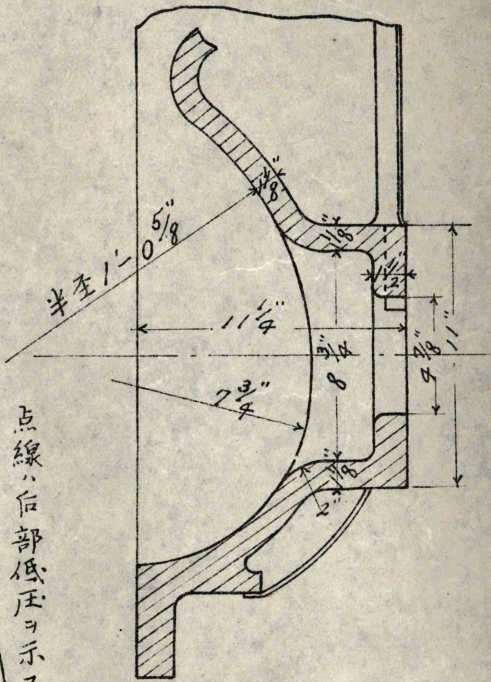
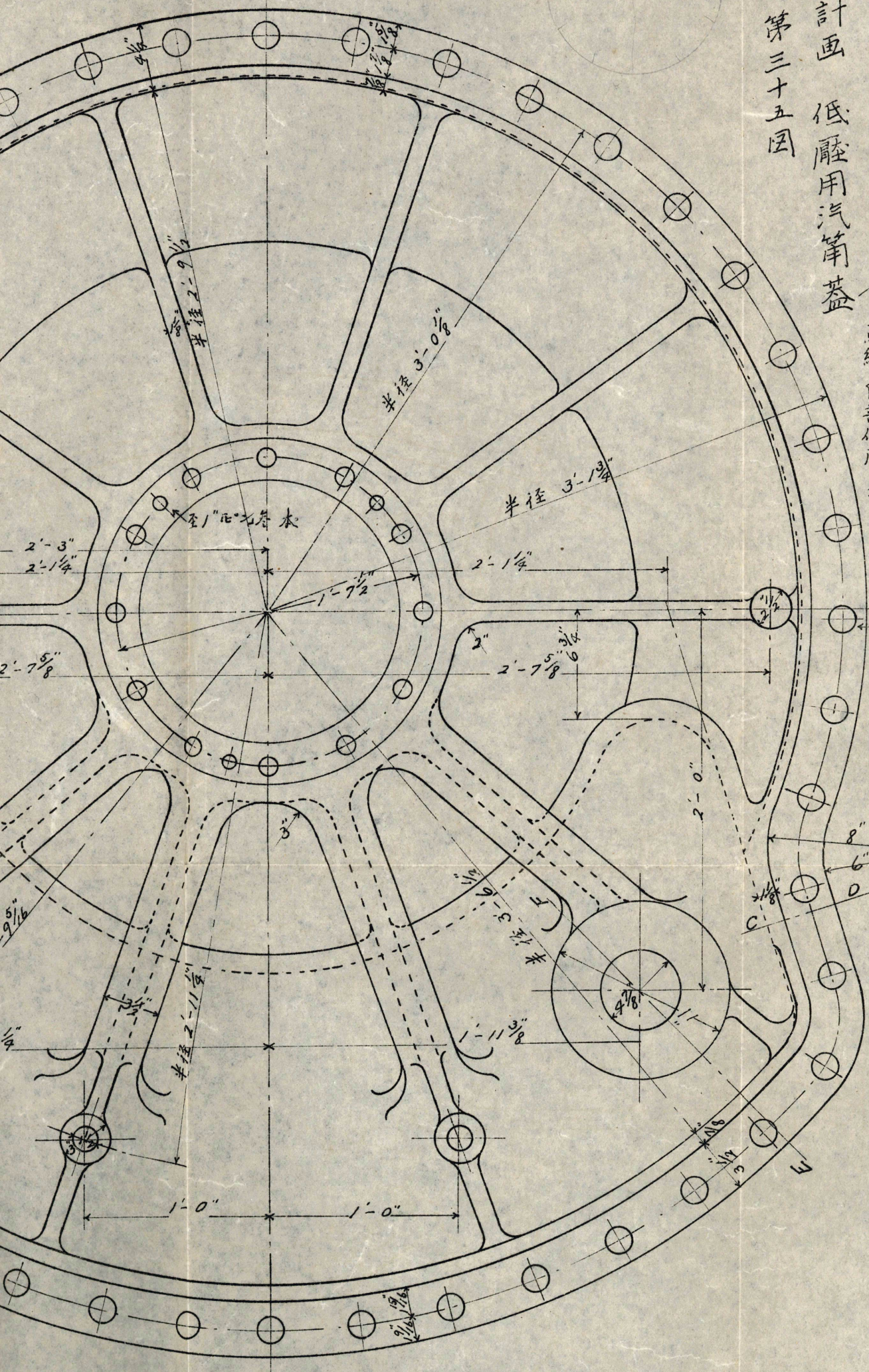

EF 切断

点線、后部低圧を示ス

至、各「スタッド」四拾四本

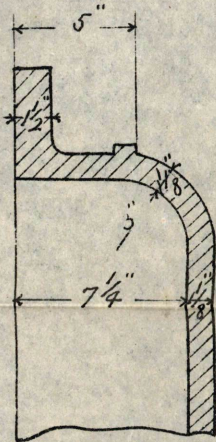

CD 切断

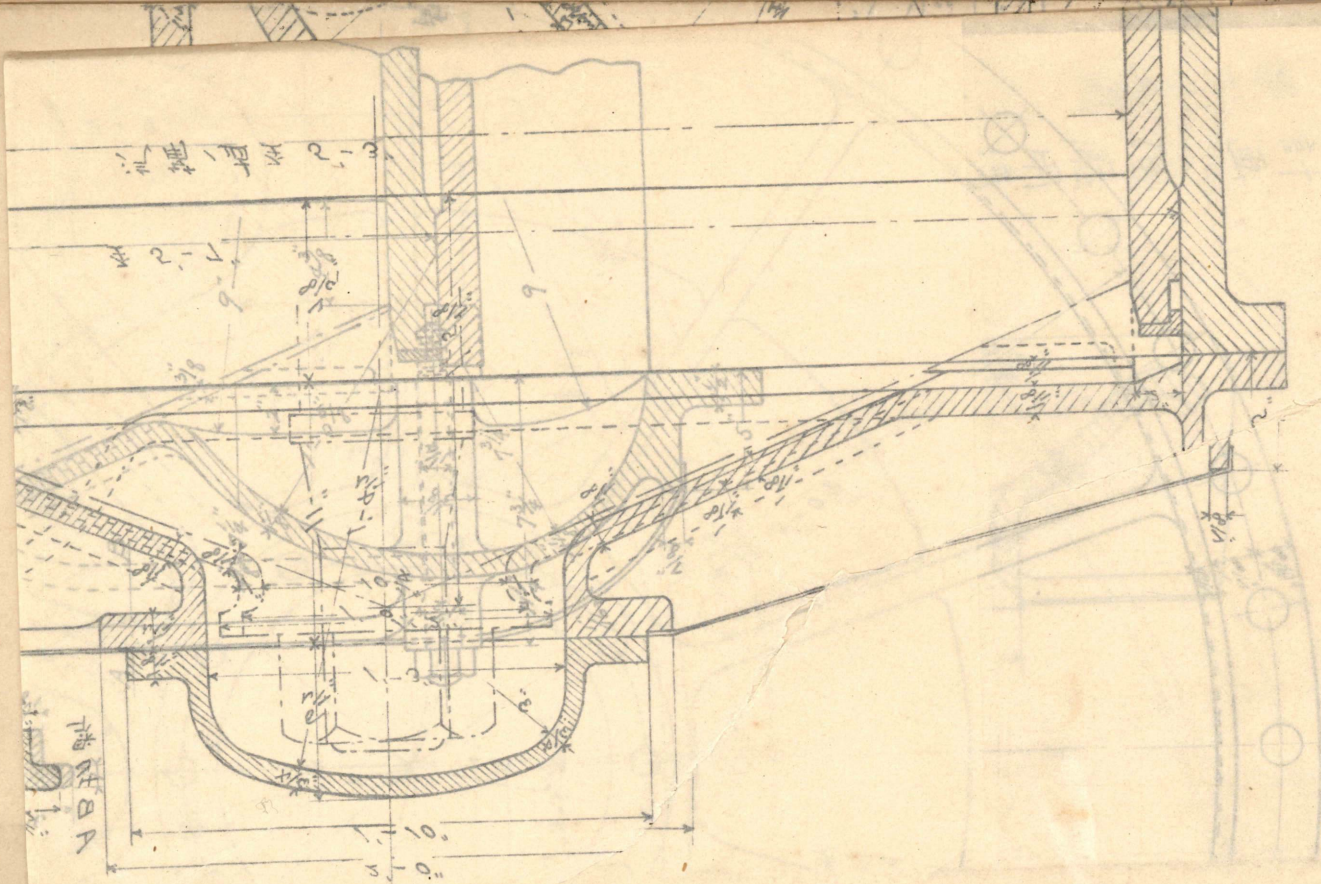

第三十七图

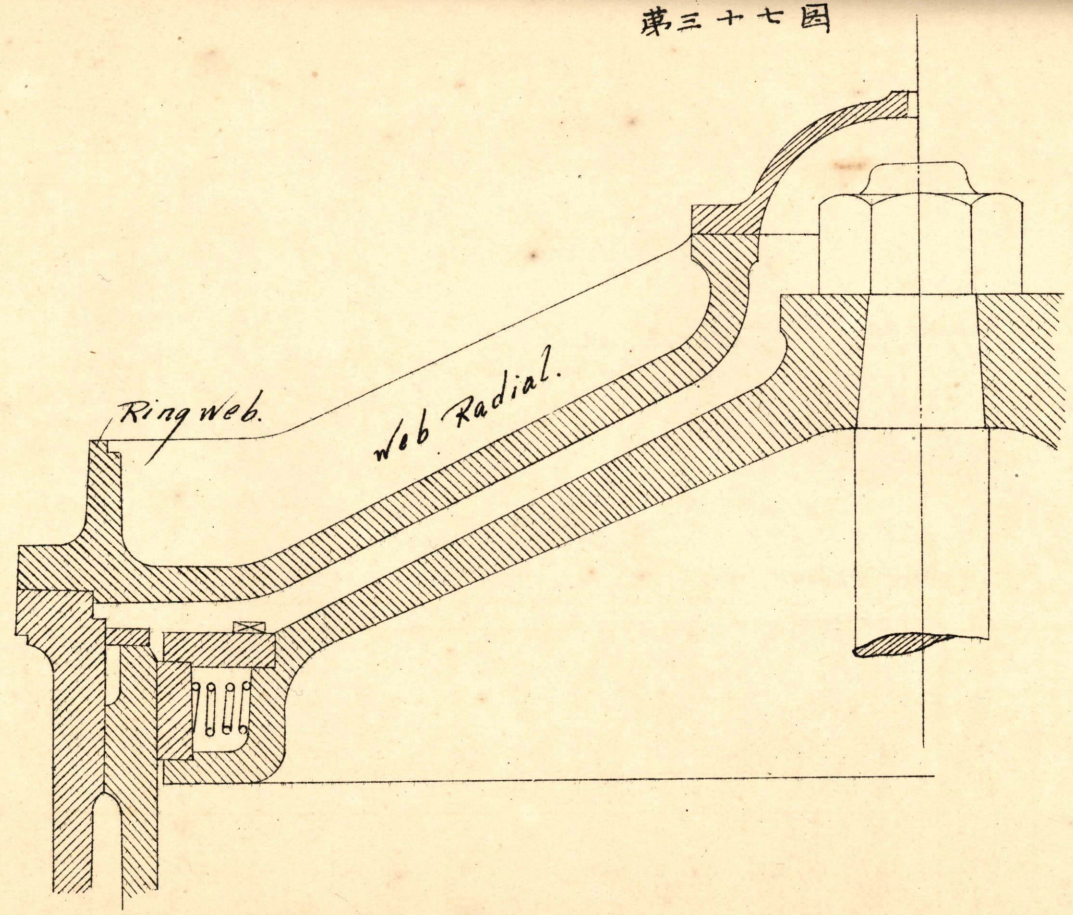

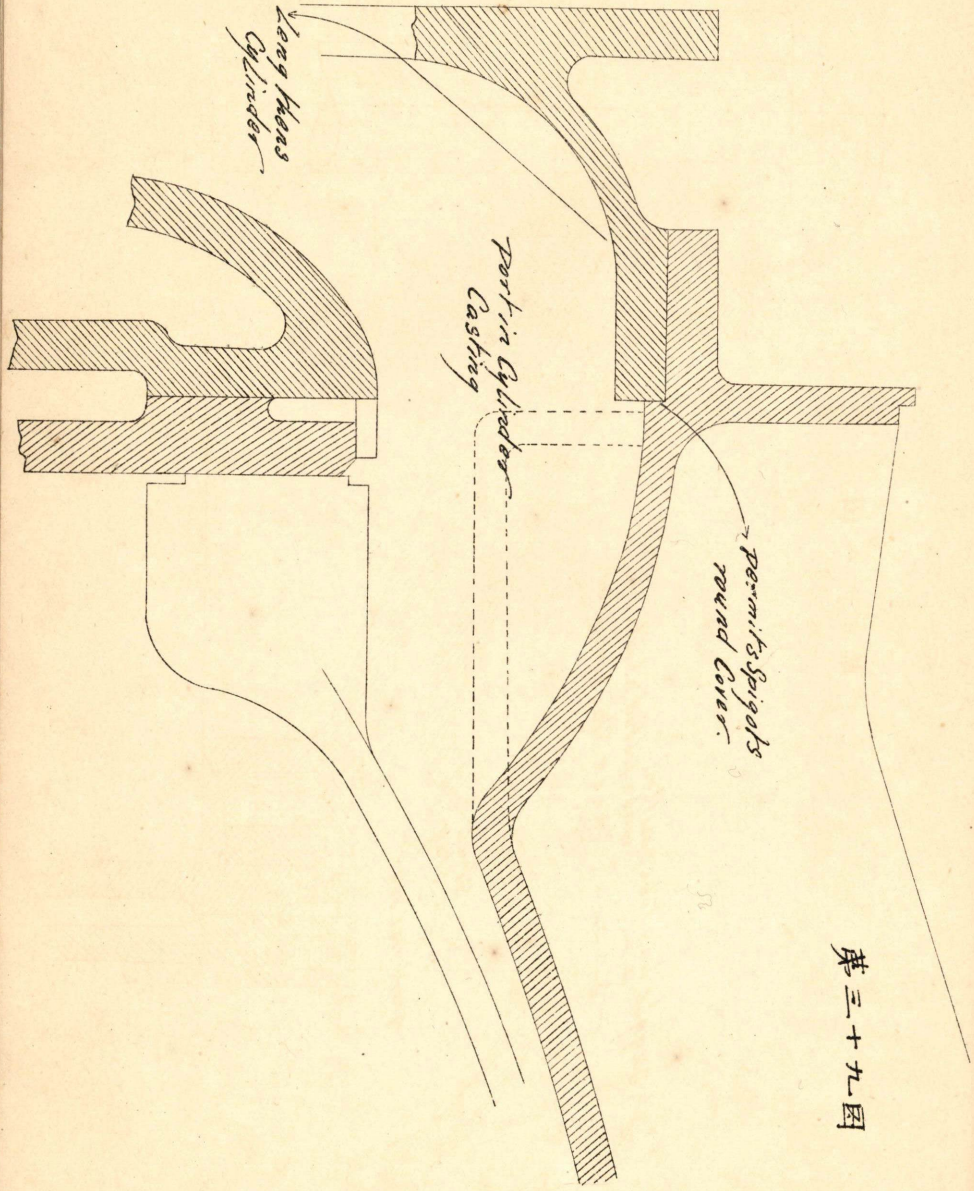

第三十九图

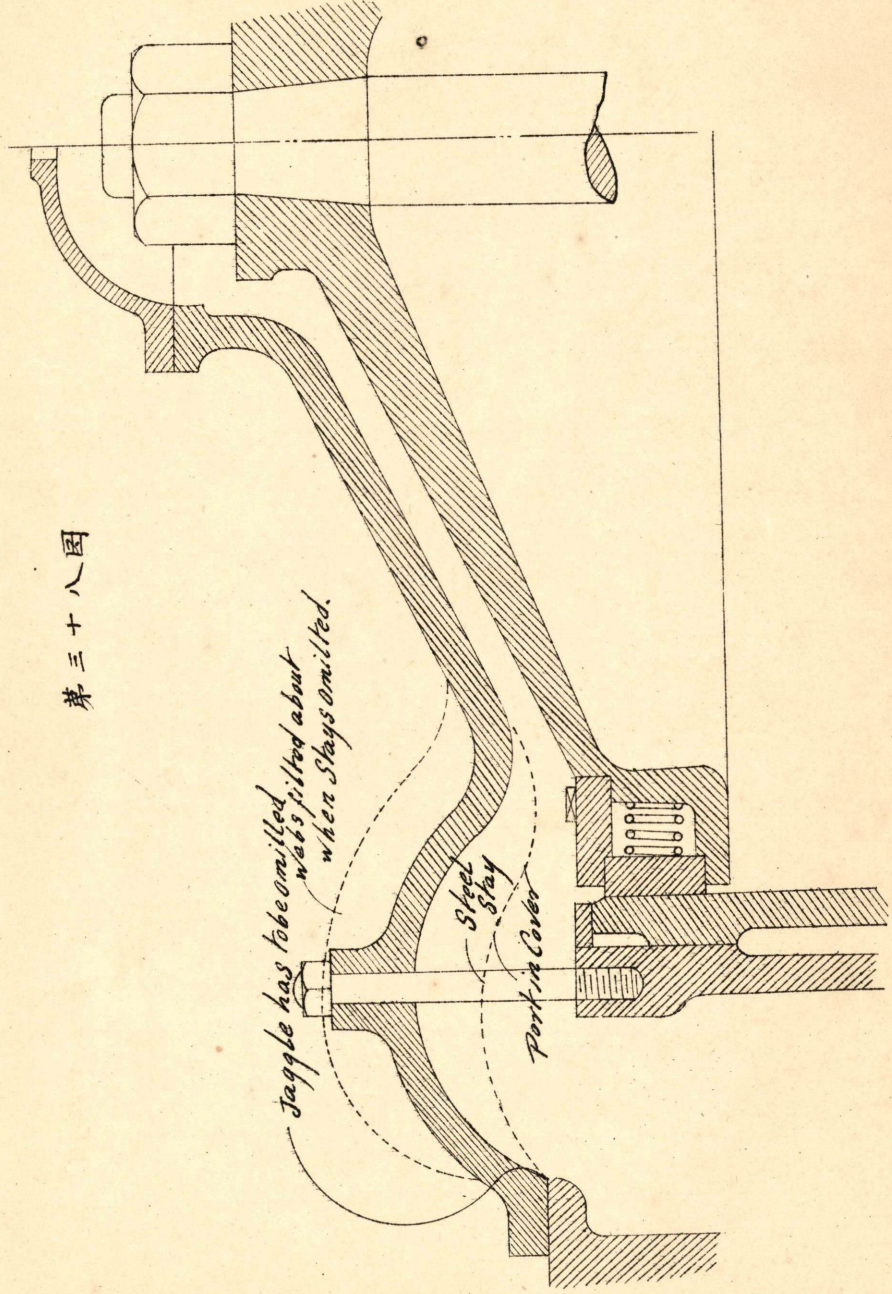

第三十八图

第四十图

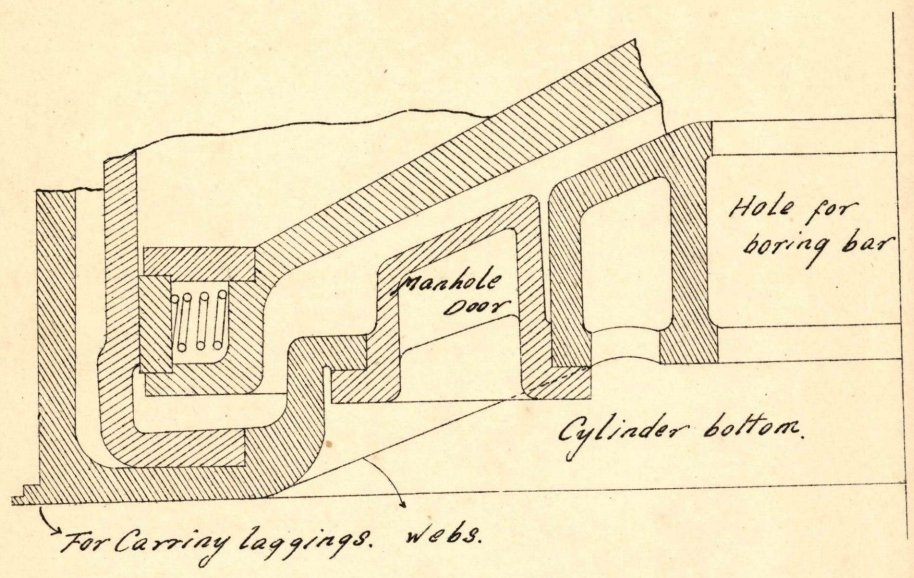

第四十一图

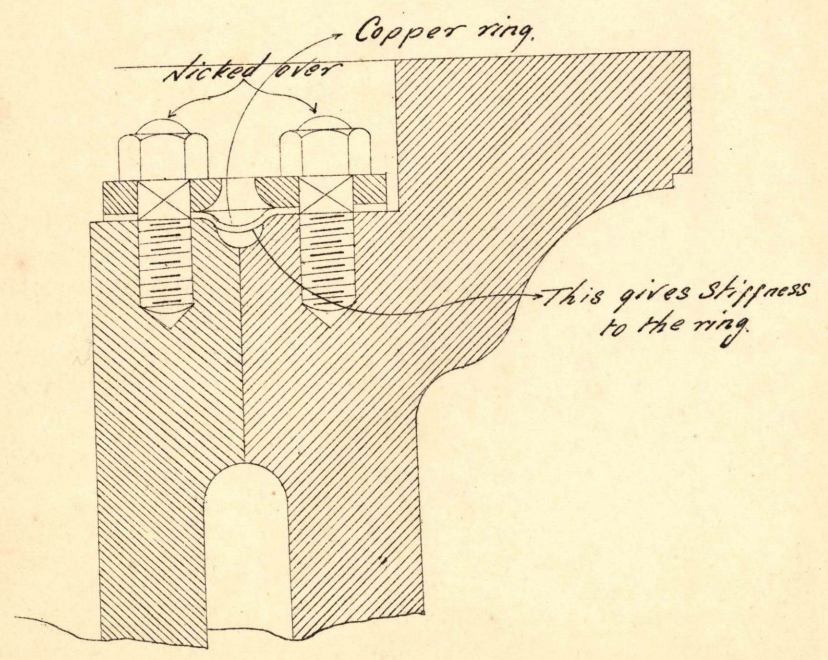

第四十二图

