

多用途支援艦 ひうち
 竣工 平成14年3月27日
 建造 日鋼鶴見
 基準排水量 980t
 全長 65m

--- 谷折り

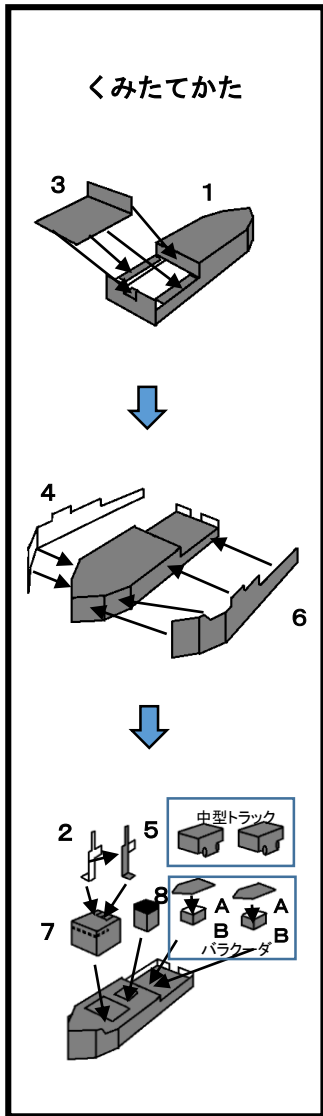

多用途支援艦ひうち AMS-4301

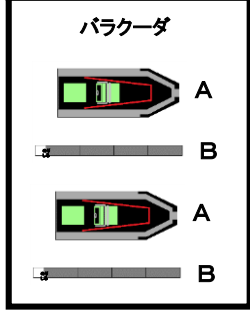
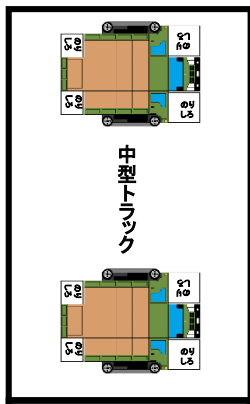
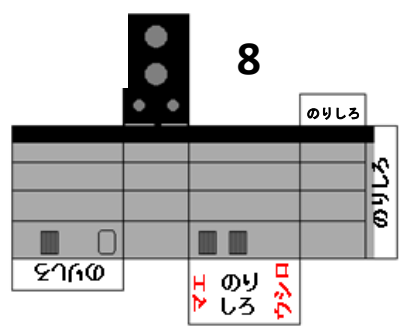
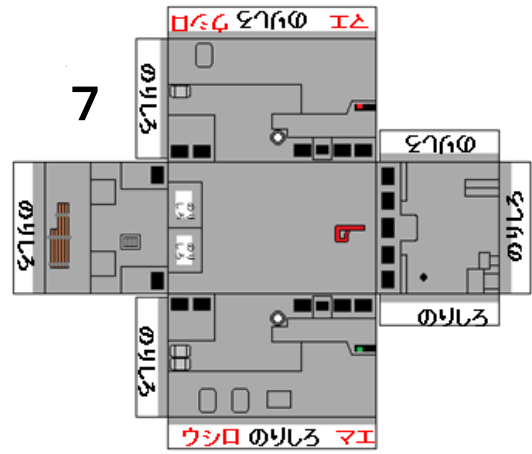
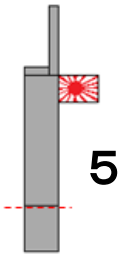
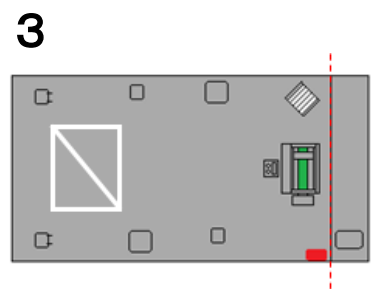
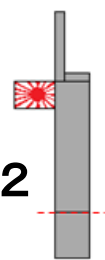