

うみねこ (男性隊員)

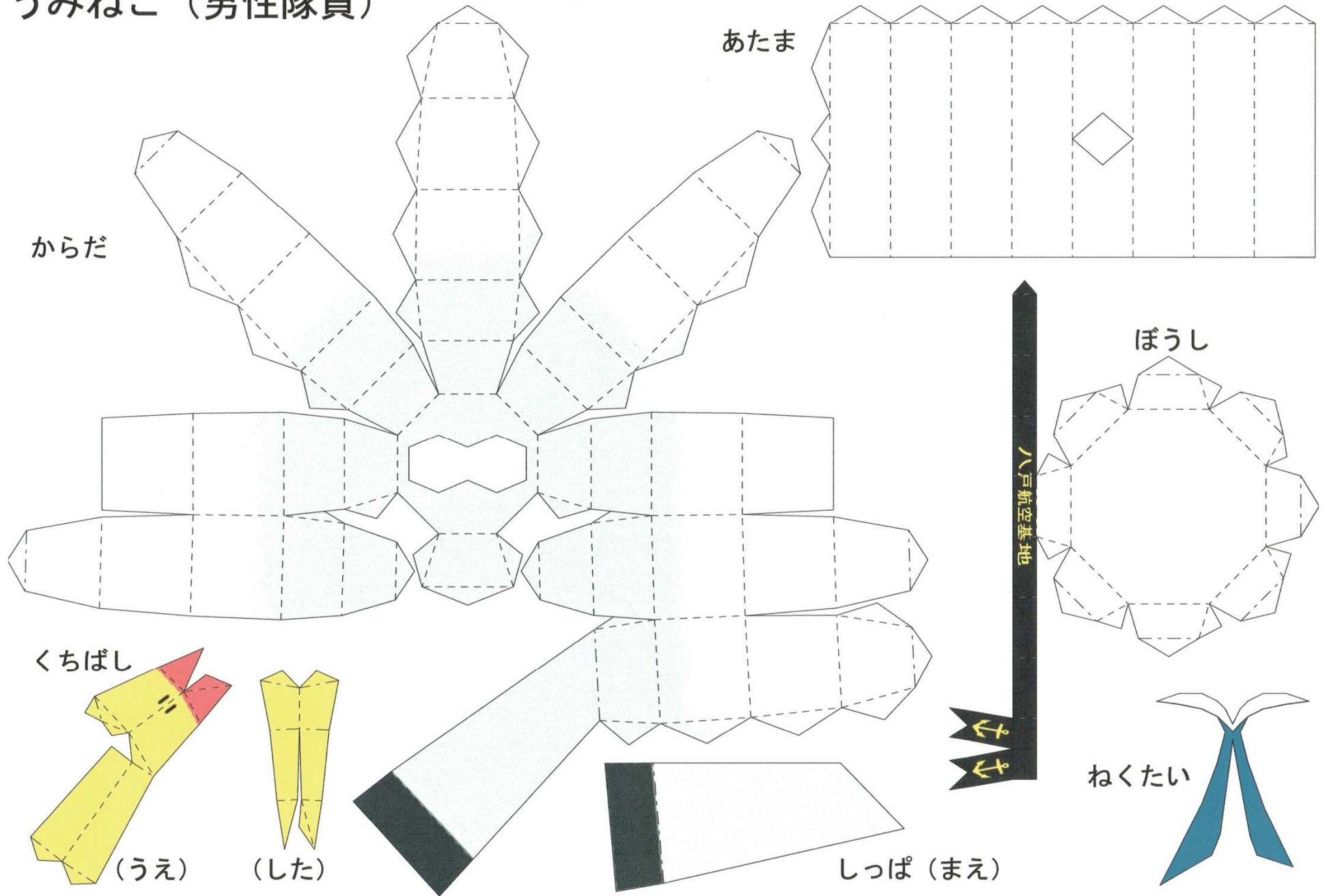

あし1

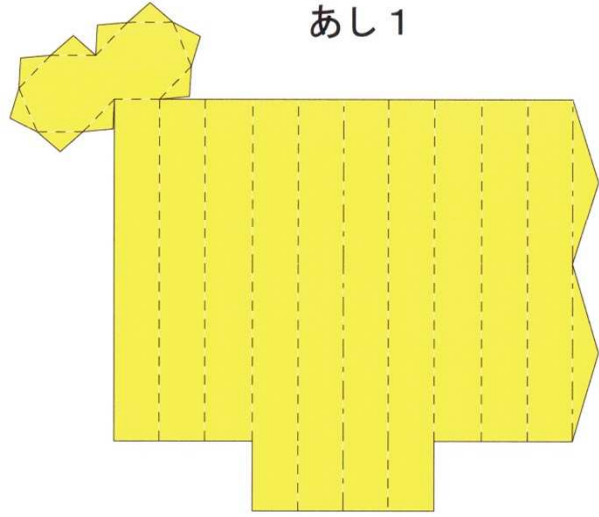

うで (みぎ)

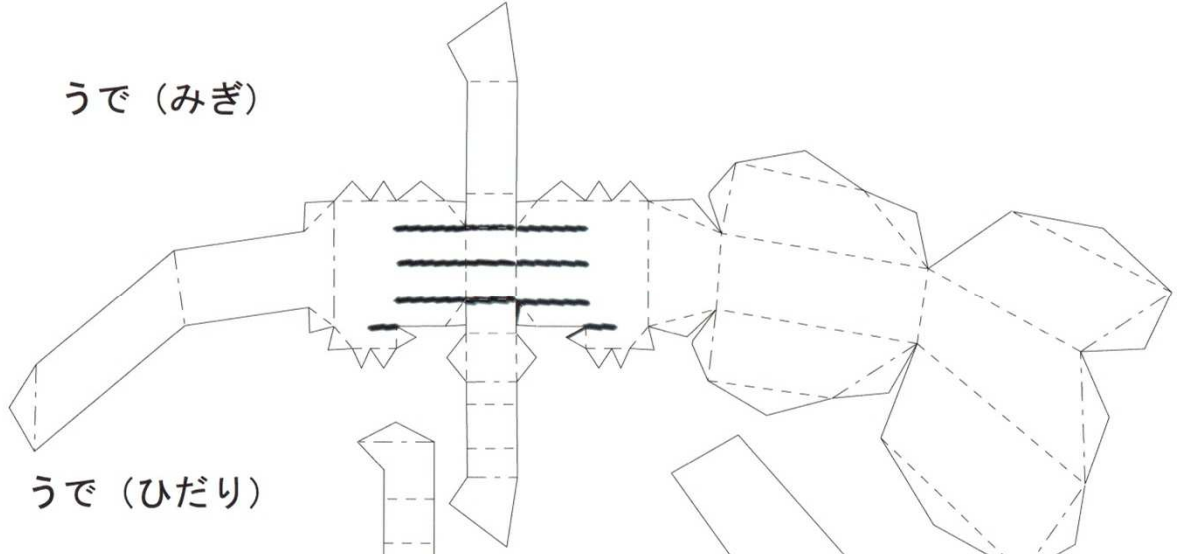

うで (ひだり)

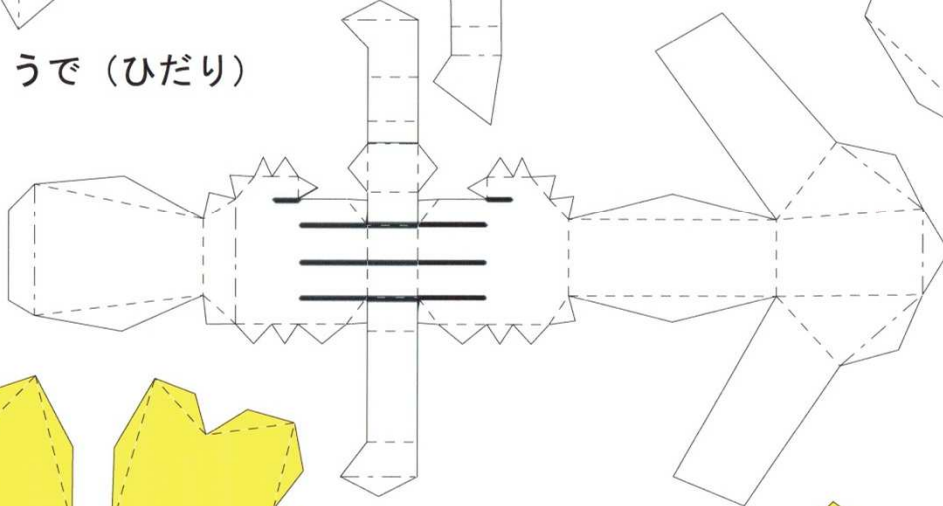

あし2

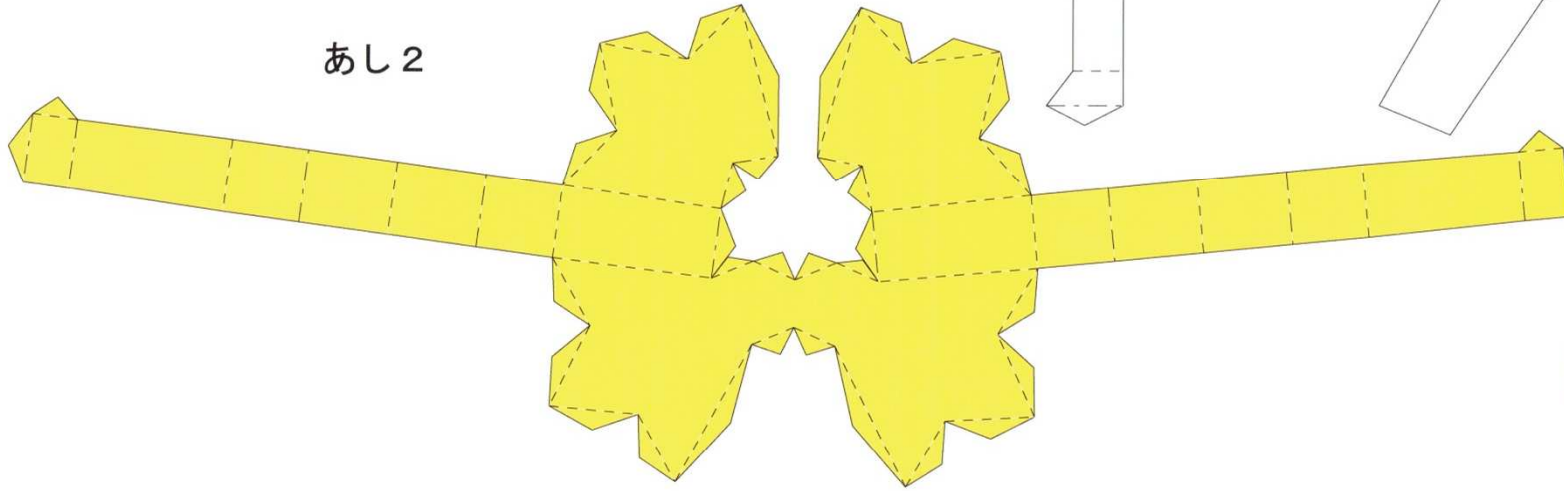

め

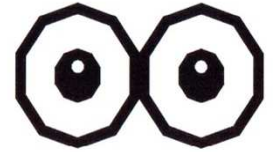

うみねこ (女性隊員)

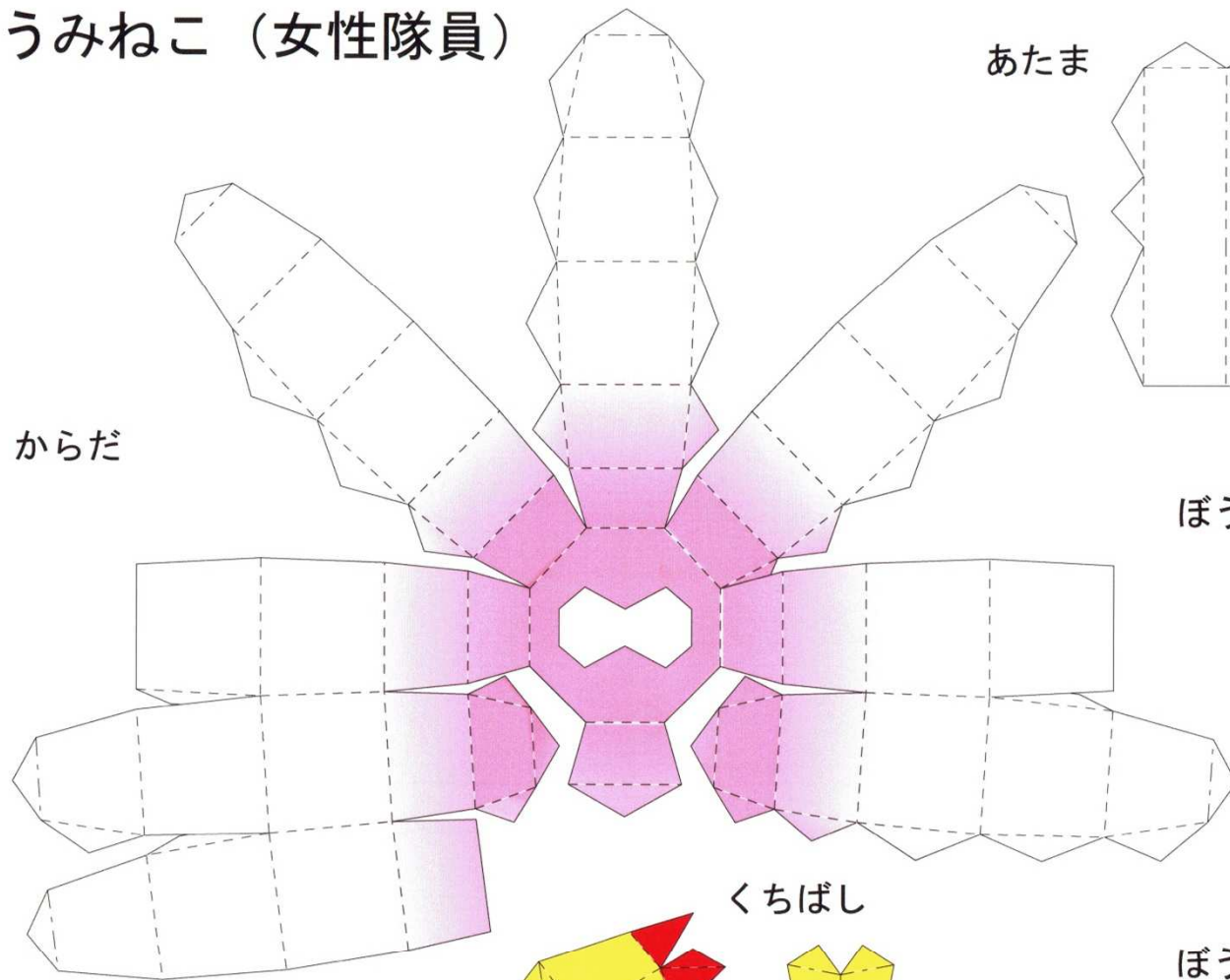

あたま

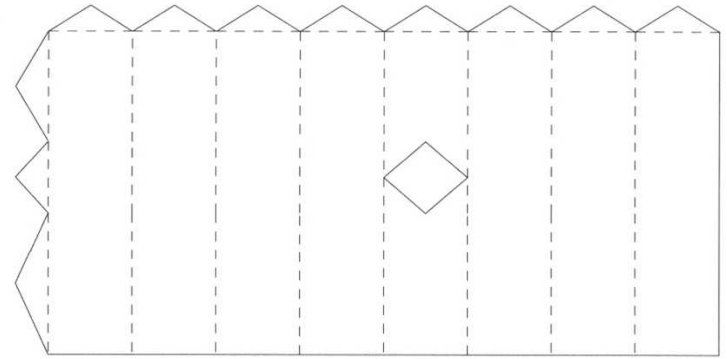

ぼうし

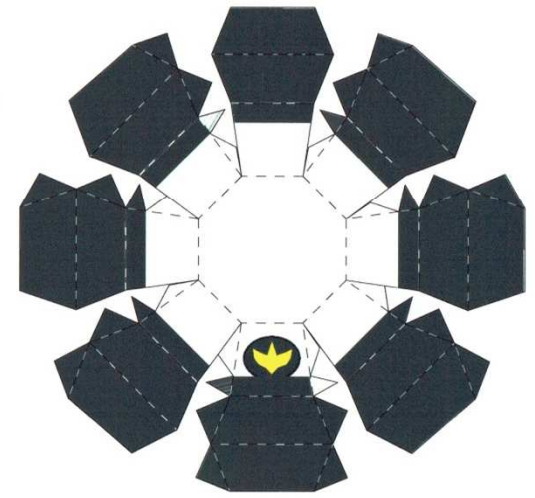

ぼうしかざり



ねくたい

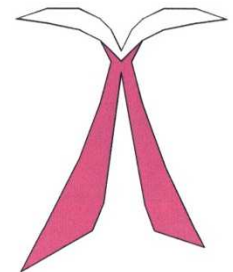

め



(みぎ)



(ひだり)

くちばし

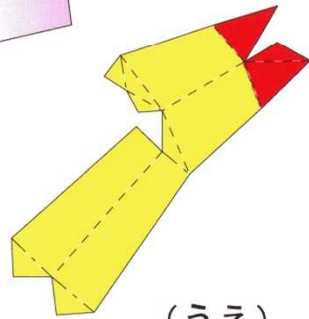

(うえ)

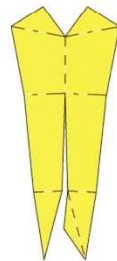

(した)

しっぽ (うしろ)

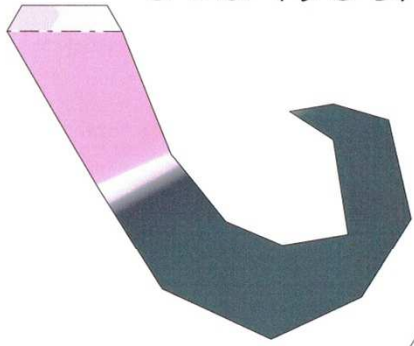

うで (みぎ)

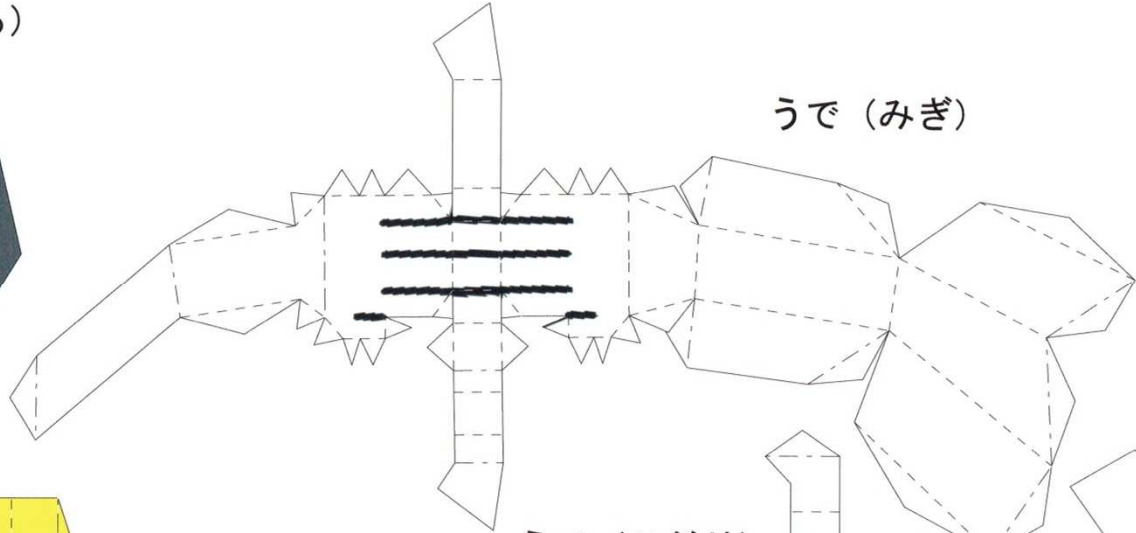

あし 1

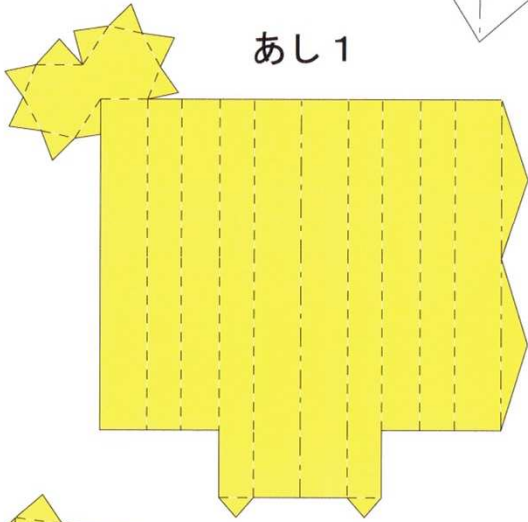

うで (ひだり)

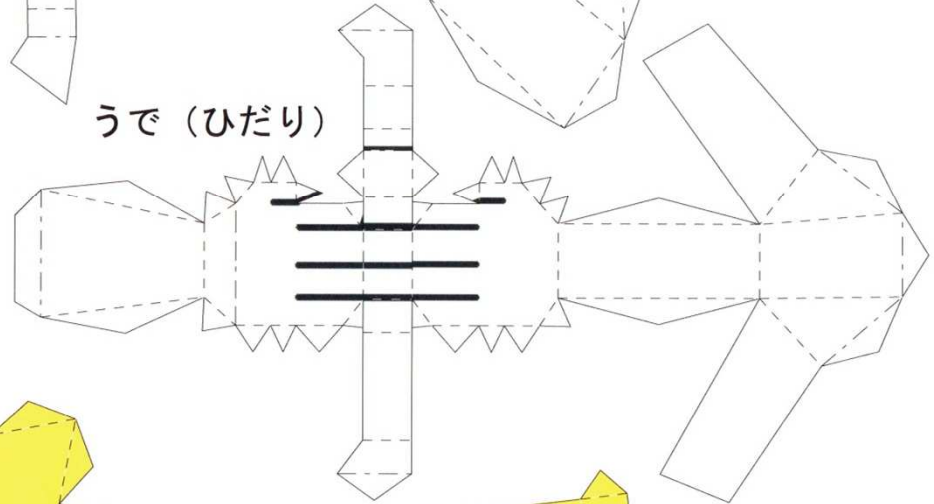

あし 2

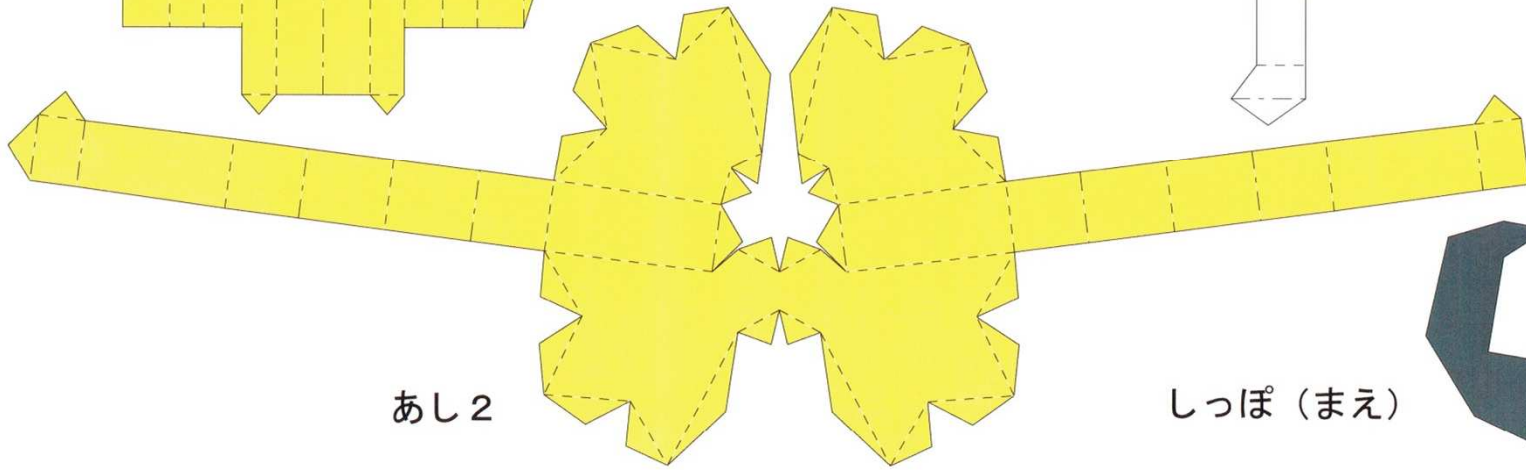

しっぽ (まえ)

