

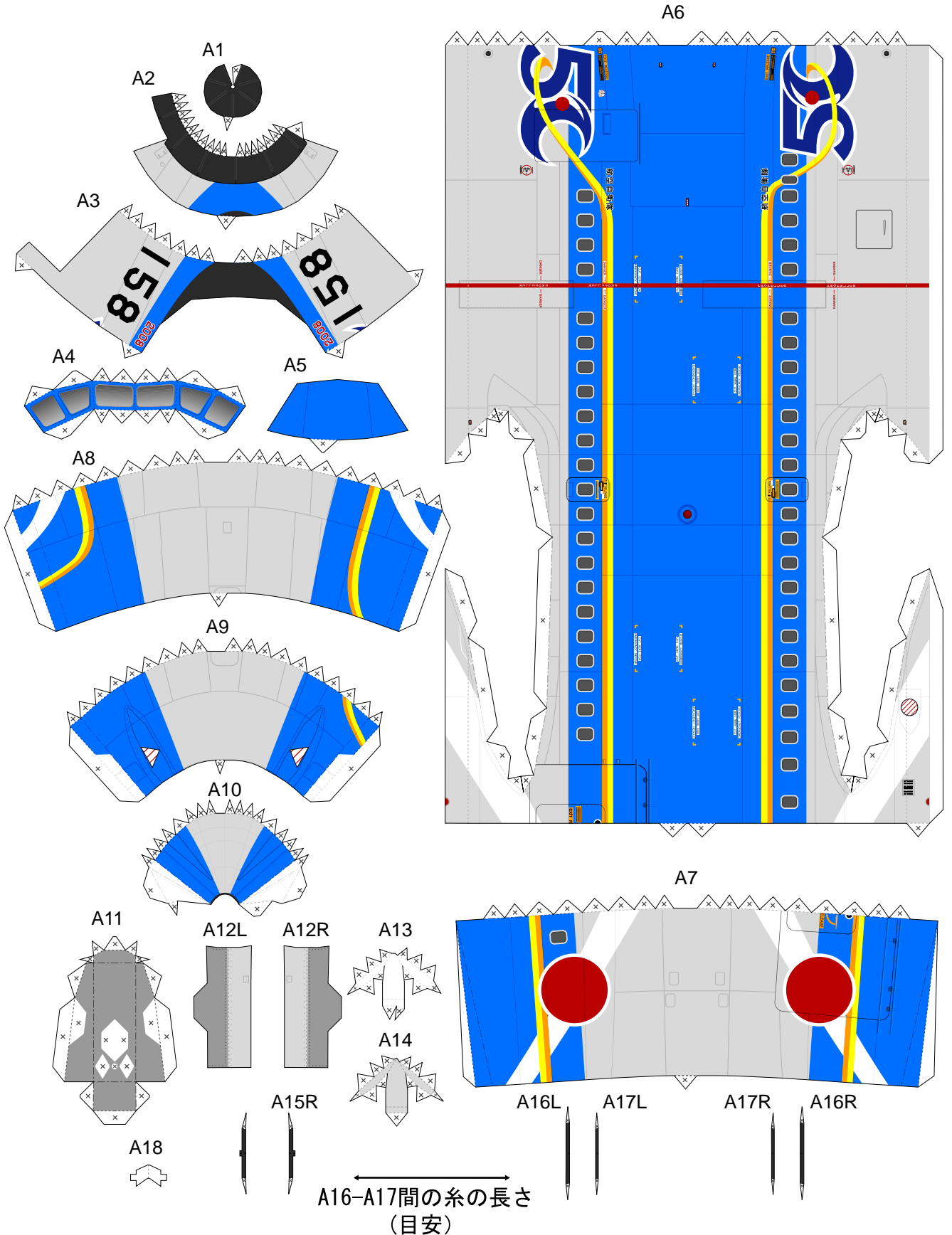

1/100scale YS-11 型輸送機
美保基地開庁 50 周年記念塗装機
ペーパークラフト

凡例	
—	切断
⋯	山折り
- - -	谷折り
▨	切り抜く
×	のりしろ

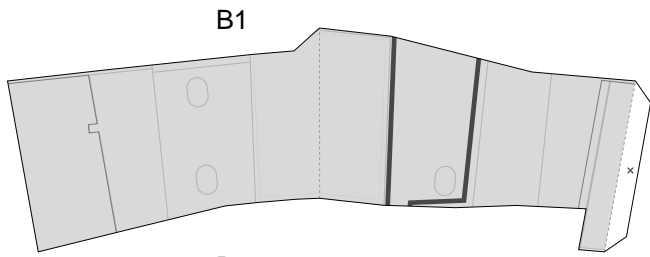



B1

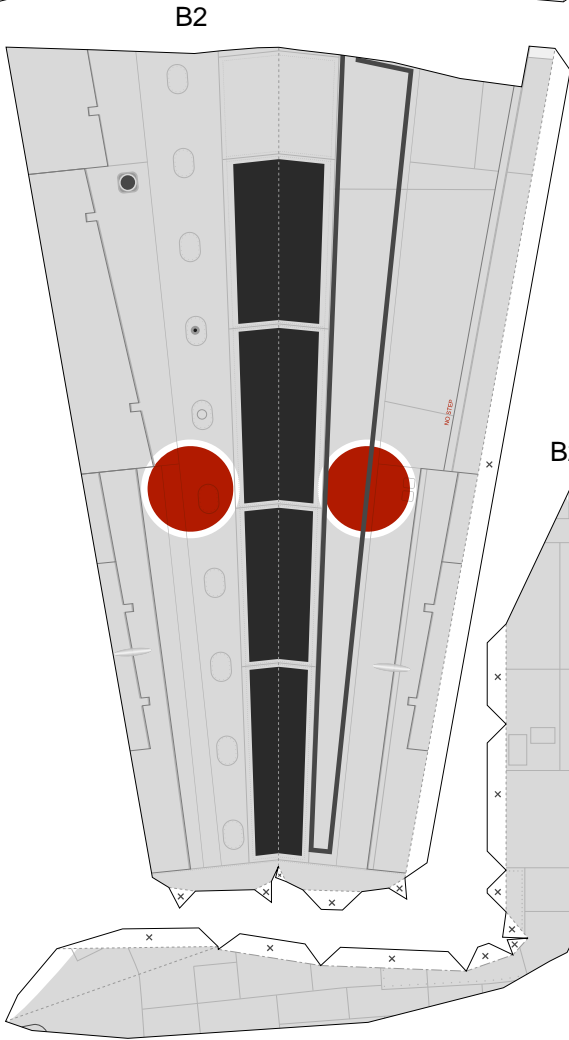

B2

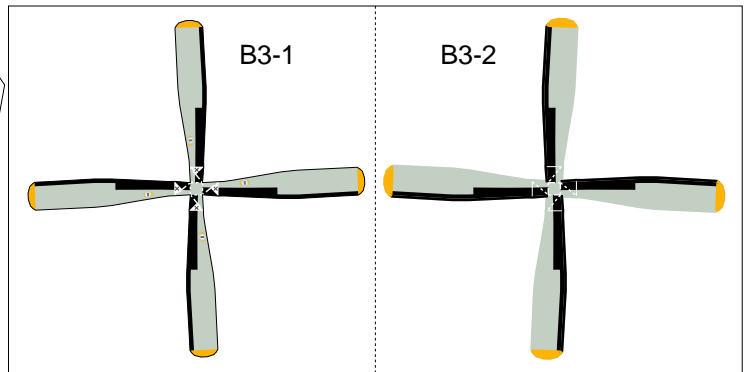

B3-1

B3-2

折り線で山折りして裏表を貼り合せてからB3-1の切断の線で表裏合わせて切断します。

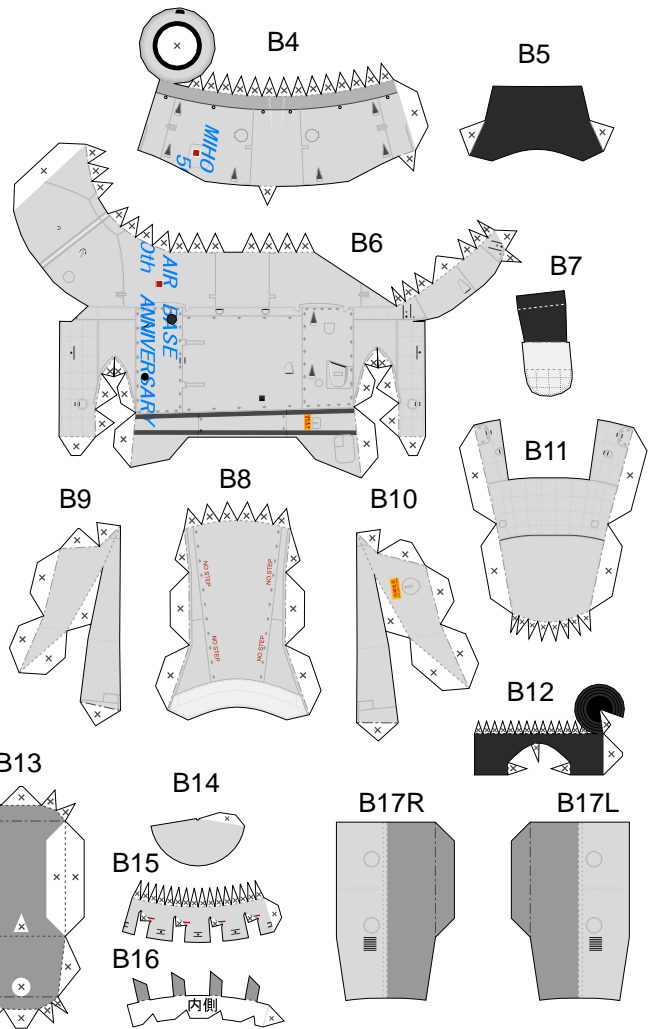

B4

B5

B21

B6

B7

B11

B9

B8

B10

B12

B13

B14

B17R

B17L

B15

B16

内側

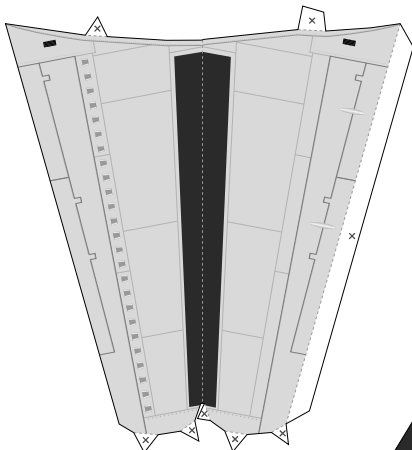

B22

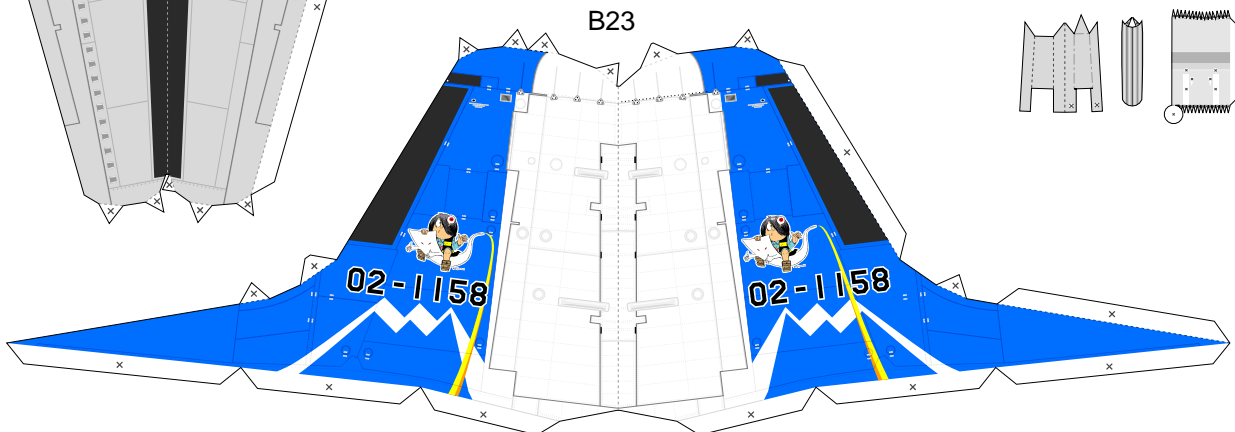

B23

B18

B19

B20

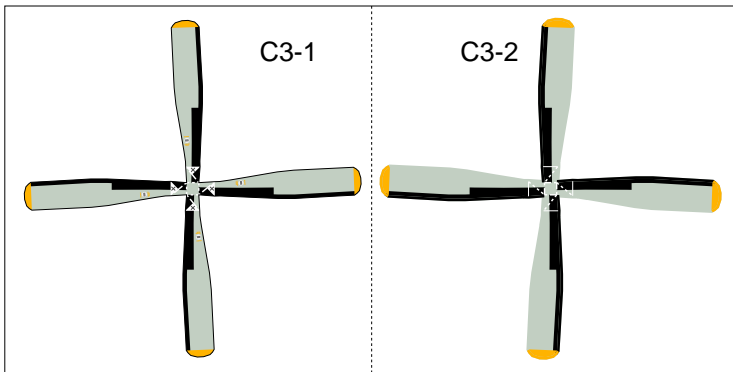

折り線で山折りして裏表を貼り合せてからC3-1の切断の線で表裏合わせて切断します。

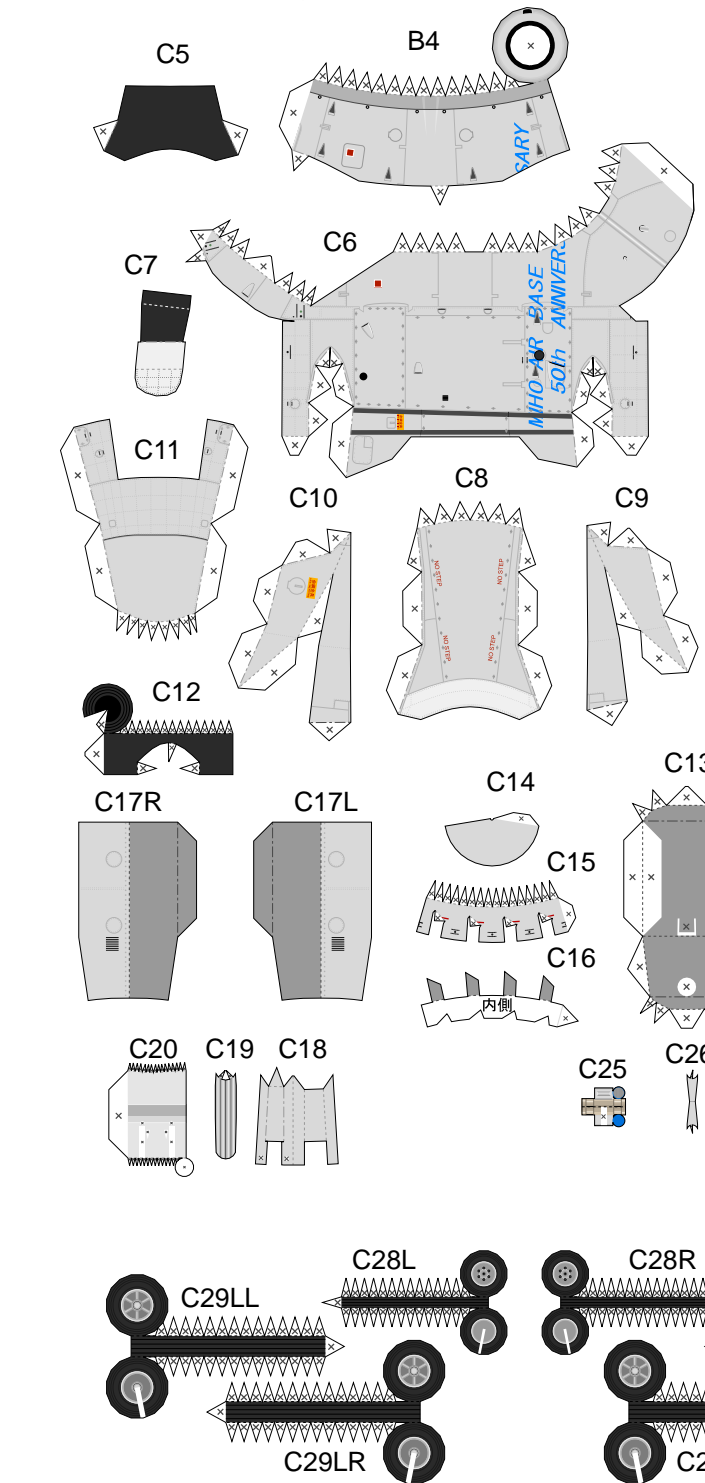
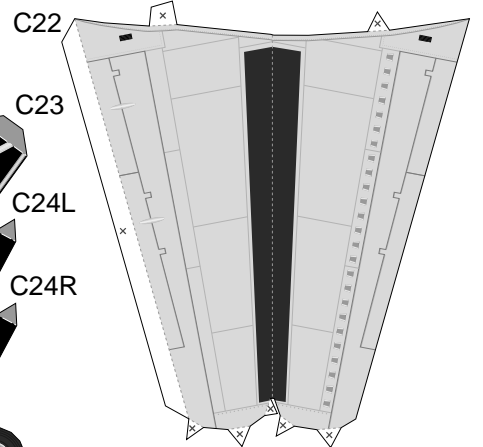
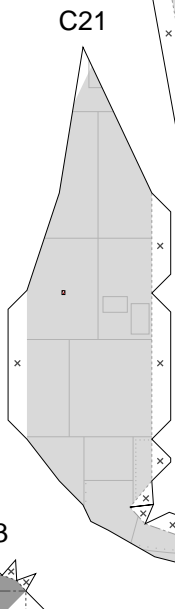
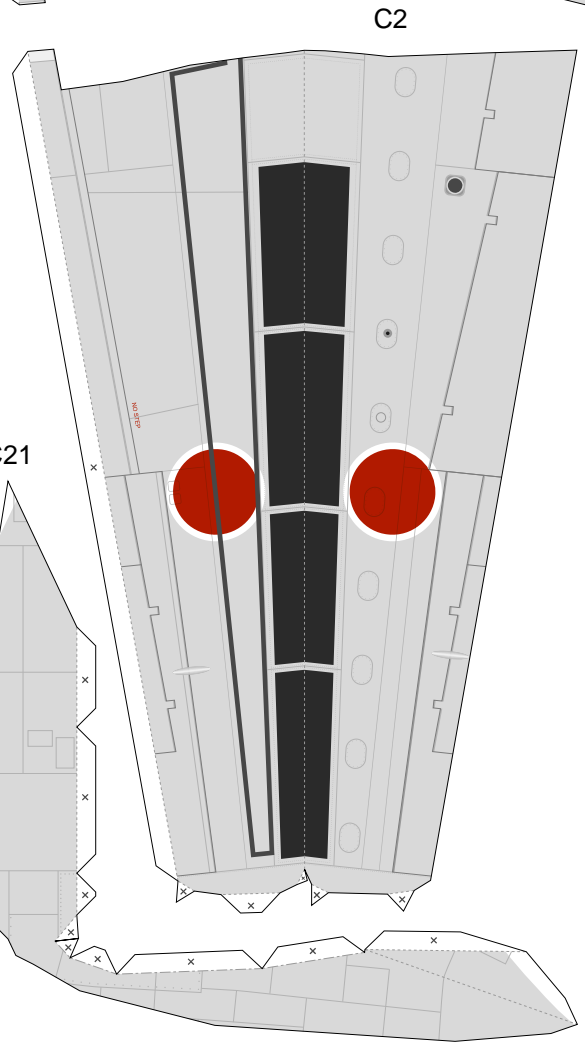
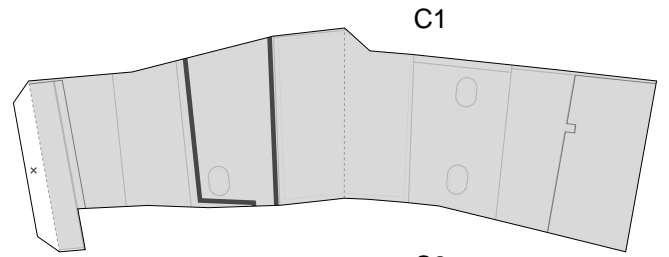

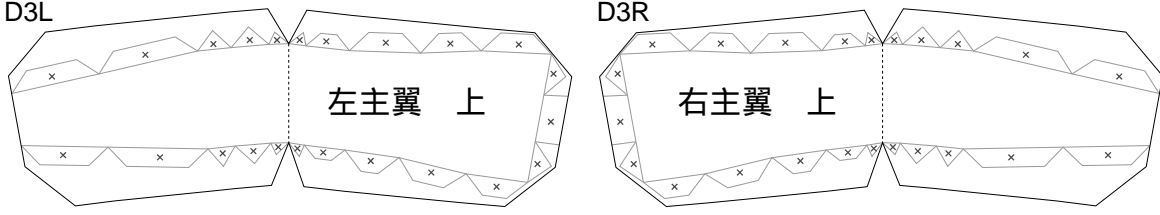
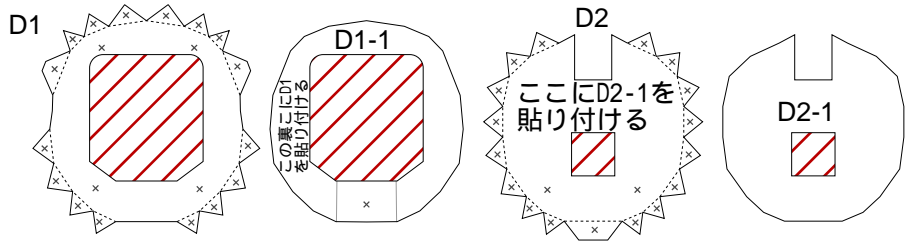

A15L-尾翼-A15R間の系の長さ(目安)

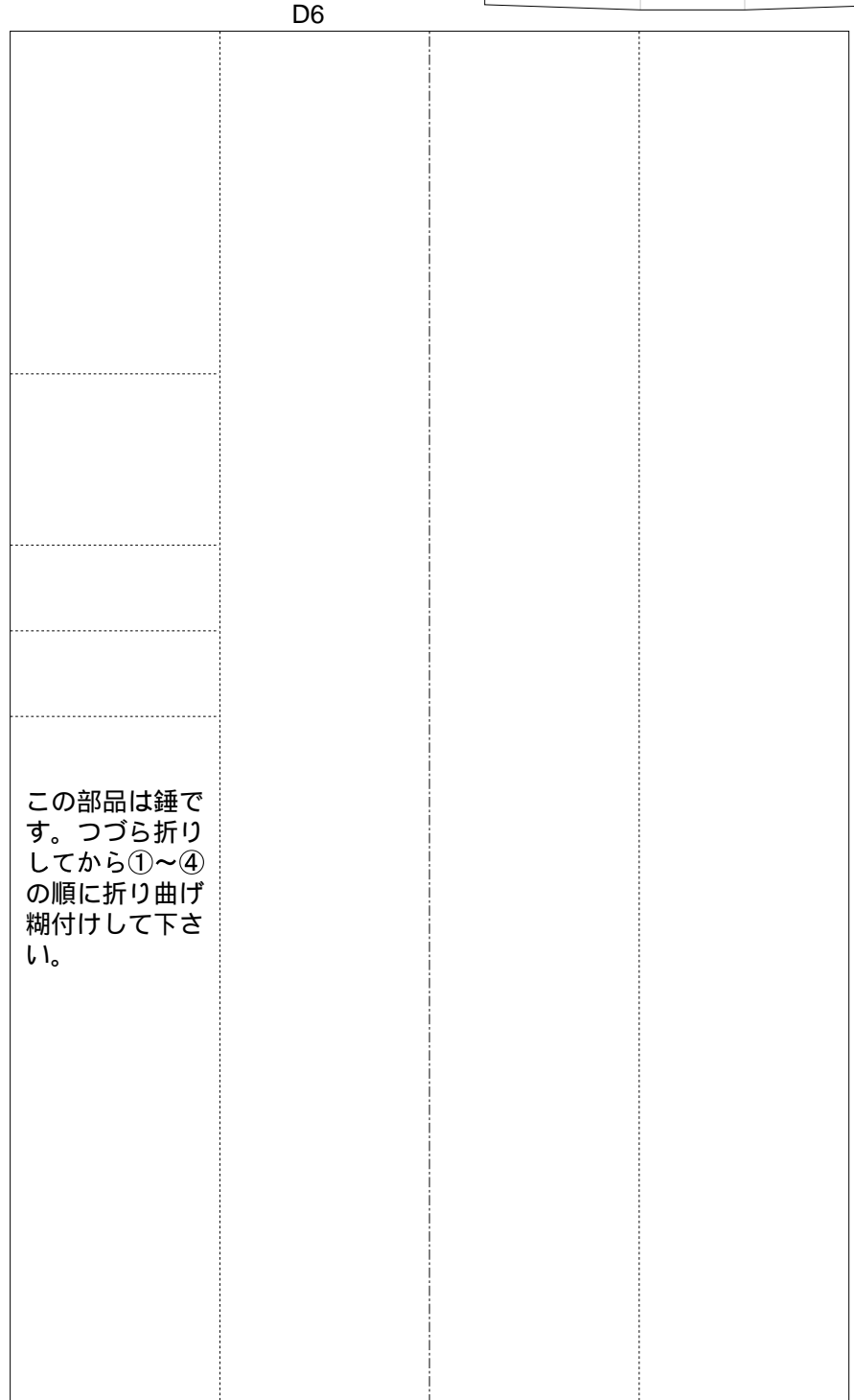

この部品は錘です。つづら折りしてから①～④の順に折り曲げ糊付けして下さい。

